



POINT MOBILE CO., LTD.
B-9F, Kabul Great Valley, 32, Digital-Ro 9Gil
Geumcheon-gu, Seoul, Korea 153-709
www.Pointmobile.co.kr

Model :	Originator :	Version :	Dept.	Date :
PM60 with Android	Jinny Cho	1.0	PC/PE/ID/PM/QA	March 12 th , 2015

PM60 Android User Manual

CONTENTS

1. INTRODUCTION	2
<i>About the PM60 Handy Terminal</i>	6
<i>Accessories</i>	6
2. SAFETY REGULATIONS HW	7
2.1. <i>General Safety Rules</i>	7
2.2. <i>Power Supply</i>	8
2.3. <i>Laser Safety</i>	9
2.4. <i>LED Safety</i>	10
2.5. <i>FCC/ EU RF Exposure</i>	10
2.6. <i>CB Scheme</i>	10
2.7. <i>FCC Part 15 Regulation</i>	10
2.8. <i>Radio Compliance</i>	11
2.9. <i>WWAN</i>	12
2.10. <i>WEEE Compliance</i>	12
3. GETTING STARTED	12
3.1. <i>Install the Battery</i>	13
3.2. <i>Charge the Batteries</i>	14
3.3. <i>LED Indicators</i>	15
3.4. <i>Guidelines for Battery Pack Use and Disposal</i>	15
3.5. <i>Boot the Terminal and Access the Home Screen</i>	18
3.6. <i>The Home Screen</i>	18
3.7. <i>Turning Power On/Off</i>	23
3.8. <i>Using the Stylus</i>	24
3.9. <i>Using File Explorer</i>	24
4. GET TO KNOW YOUR DEVICE	25
4.1. <i>Feature of Your Device</i>	25
4.2. <i>PM60 Handy Terminal</i>	25
4.3. <i>Front Panel Layout</i>	26
4.4. <i>Display</i>	0
4.5. <i>Using Screen Protectors</i>	0
4.6. <i>Installing Your Screen Protector</i>	28
4.7. <i>Back Panel Layout</i>	30
4.8. <i>Left Side Panel Layout</i>	3
4.9. <i>Installing Memory Cards</i>	31
4.10. <i>Right Side Panel Layout</i>	32
4.11. <i>Top Panel Layout</i>	32
4.12. <i>Bottom Panel Layout</i>	33

4.13.	<i>Peripherals and Accessories</i>	34
4.14.	<i>MicroUSB Cable</i>	34
4.15.	<i>Li-ion Battery Packs</i>	35
4.16.	<i>Battery Power</i>	35
4.17.	<i>Main Battery Pack</i>	35
4.18.	<i>Managing Main Battery Power</i>	36
4.19.	<i>Resetting the Terminal</i>	37
4.20.	<i>Suspend Mode</i>	38
4.21.	<i>Memory Allocation</i>	38
4.22.	<i>Care and Cleaning of the Products</i>	38
4.23.	<i>PM60 Technical Specifications</i>	38
5.	USING THE KEYPAD	40
5.1.	<i>Numeric Keypad Layout</i>	40
5.2.	<i>Navigation Keys</i>	40
5.3.	<i>Basic Keys</i>	40
5.4.	<i>Alpha/Numeric Modes</i>	41
5.5.	<i>Alpha Indicators on the Numeric Keys</i>	41
5.6.	<i>BLUE Key Combinations</i>	41
5.7.	<i>Program Buttons</i>	42
6.	USING THE IMAGE ENGINE	43
6.1.	<i>Overview</i>	44
6.2.	<i>Available Image Engines</i>	44
6.3.	<i>Depth of Field</i>	44
6.4.	<i>Supported Bar Code Symbologies</i>	45
6.5.	<i>Activating the Engine</i>	45
6.6.	<i>Using Demos</i>	45
6.7.	<i>Decoding</i>	46
6.8.	<i>To Decode a Bar Code</i>	46
6.9.	<i>Sample Bar Codes</i>	46
6.10.	<i>Omni-Directional Scanning Positions</i>	46
6.11.	<i>Capturing Images (IT5300SR Engine Only)</i>	47
7.	USING THE LASER ENGINE	47
7.1.	<i>Overview</i>	47
7.2.	<i>Available Laser Engines</i>	47
7.3.	<i>Depth of Field</i>	47
7.4.	<i>Supported Bar Code Symbologies</i>	48
7.5.	<i>Activating the Engine</i>	48
7.6.	<i>Using Demos</i>	48
7.7.	<i>Decoding a Bar Code</i>	48
7.8.	<i>Sample Bar Code</i>	49
7.9.	<i>Scanning Positions</i>	49

8. USING SCANWEDGE	49
8.1. Overview	49
8.2. Enabling ScanWedge	49
9. USING CONTROL PANEL	50
9.1. Settings	50
9.2. Program Buttons Settings	64
9.3. NoNaviBar	65
9.4. NoSIP	65
10. COMMUNICATION	65
10.1. Communication Options	65
10.2. Communication Type	66
10.3. Hardware Requirements for Setup	66
10.4. Connect to a Windows computer via USB	66
10.5. Exploring the Terminal from the Workstation	67
10.6. Wireless Radios	67
10.7. Connecting the Terminal to a Wireless Network	67
10.8. WLAN (802.11b/g/n Radio)	69
11. BLUETOOTH HANDLER	70
11.1. Enabling the Bluetooth Radio	70
11.2. Connecting to Other Devices	70
11.3. Pairing Bluetooth Devices	71
11.4. Setting Up a Bluetooth Printer	71
12. SINGLE SLOT DOCKING CRADLE/ SINGLE SLOT ETHERNET CRADLE DEVICE	71
12.1. Overview	71
12.2. Battery Charging	71
12.3. Power Supply	72
12.4. Front Panel	72
12.5. Back Panel	72
12.6. Powering the Single Slot Docking Cradle or Single Slot Ethernet Cradle Device	73
12.7. Charging the Battery	74
12.8. Technical Specifications	74
13. SINGLE SLOT DOCKING CRADLE/ SINGLE SLOT ETHERNET CRADLE DEVICE	75
13.1. Overview	75
13.2. Power Supply	75
13.3. Front Panel	76
13.4. Back Panel	77
13.5. Charging the Battery	77
13.6. Technical Specifications	78

1. Introduction

Thank you for purchasing PM60 handy terminal.

This manual generally provides you with the safety information and basic features and operations of the PM60 device. Please read all safety precautions and this manual carefully before using your handy terminals and peripherals to ensure safe and proper use.

PM60 Model Name & P/ N

P/ N	Spec	CE Model Name
PM60GP52356E0T	Wifi/BT, 1D(N4313), Camera, Numeric, WEH6.5	M60GP74356E0C
PM60GP54356E0T	Wifi/BT, 1D(N4313), Camera, QWERTY, WEH6.5	
PM60GP72356E0T	Wifi/BT, 2D (N560x) , Camera,Numeric, WEH6.5	
PM60GP74356E0T	Wifi/BT, 2D (N560x), Camera, QWERTY, WEH6.5	
PM60G152356E0C	3G, Wifi/BT, 1D(N4313), Camera, GPS, Numeric, WEH6.5	PM60G174356E0C
PM60G154356E0C	3G, Wifi/BT, 1D(N4313), Camera, GPS, QWERTY, WEH6.5	
PM60G152357E0C	3G, Wifi/BT, 1D(N4313), Camera, GPS, Numeric, Android 4.2	
PM60G154357E0C	3G, Wifi/BT, 1D(N4313), Camera, GPS, QWERTY, Android 4.2	
PM60G152356KKC	3G-K, Wifi/BT, 1D(N4313), Camera, GPS, Numeric, WEH6.5	
PM60G172356KKC	3G-K, Wifi/BT, 2D(N560x), Camera, GPS, Numeric, WEH6.5	
PM60G174356KKC	3G-K, Wifi/BT, 2D (N560x), Camera,GPS, QWERTY, WEH6.5	
PM60G152357KKC	3G-K, Wifi/BT, 1D(N4313), Camera, GPS, Numeric, Android 4.2	
PM60G172357KKC	3G-K, Wifi/BT, 2D (N560x), Camera, GPS, Numeric, Android 4.2	
PM60G174357KKC	3G-K, Wifi/BT, 2D (N560x), Camera, GPS, QWERTY, Android 4.2	
PM60G172356E0C	3G, Wifi/BT, 2D (N560x)), Camera, GPS, Numeric, WEH6.5	
PM60G174356E0C	3G, Wifi/BT, 2D (N560x), Camera,GPS, QWERTY, WEH6.5	
PM60G172357E0C	3G, Wifi/BT, 2D (N560x), Camera, GPS, Numeric, Android 4.2	
PM60G174357E0C	3G, Wifi/BT, 2D (N560x), Camera, GPS, QWERTY, Android 4.2	

About the PM60 Handy Terminal

The new PM60 is the latest generation handy terminal device, combining a pocket sized rugged form factor built on Android 4.2.2(Jelly Bean) operation system. The PM60 is designed for retail warehousing and logistics applications where maximum performance and durability is required in compact Pointmobile device.

The PM60 handy terminal is available in different models depending on the options.

Accessories

- **Cradles** (including DC 5V 4A Adaptor)
 - 60-SSC (Single Slot Cradle)
 - 60-SEC Single Ethernet Cradle

- **Batteries**
 - 4000mAh Battery Pack, Standard Capacity

- **Power Supply**
 - AC Adaptor, INPUT: AC100~ 240V 50/60Hz, OUTPUT: DC5V 1.8A with MicroUSB type

- **Cables**
 - MicroUSB Cable

- **Others**
 - Stylus Pen and tether
 - Wrist Lanyard
 - Handstrap

PM60 handy terminal contains the following items basically:

- Handy terminal
- MicroUSB Cable
- 5V/1.8A AC Adaptor with MicroUSB type
- AC Plugs
- Battery Pack
- Stylus Pen and tether
- Handstrap
- LCD Screen Protection Film

- Quick Start Guide

NOTE: Keep the original packaging for use when sending products to the technical assistance center. Damage caused by improper packaging is not covered under the warranty

NOTE: Rechargeable battery packs are not initially charged or discharged. Before you begin to use, you must charge the battery packs first. See Paragraph 3.2.

2. Safety Regulations

Symbols in this manual

In this manual, some important items are described with the symbols shown below. Be sure to read these items before using this equipment.



WARNING

Indicates a potentially hazardous situation which, if not avoided, could result in death serious injury, or serious damage, or fire in the equipment or surrounding objects.

AVERTISSEMENT Le terme **AVERTISSEMENT** indique une situation potentiellement dangereuse qui, si elle n'est pas évitée, peut entraîner la mort, des blessures graves, des dommages importants ou l'incendie d'objets et biens d'équipement environnants.



CAUTION

Indicates a potentially hazardous situation which, if not avoided, may result in minor or moderate injury, partial damage to the equipment or surrounding objects, or loss of data.

ATTENTION Le terme **ATTENTION** indique une situation potentiellement dangereuse qui, si elle n'est pas évitée, peut entraîner des blessures mineures ou modérées, des dégâts partiels à l'équipement, aux objets environnants ou la perte de données.



NOTE

Indicates information to which you should pay attention when operating the equipment.

This section outlines the safety precautions associated with using PM60 handy terminal.

NOTE: PM60 handy terminals meet or exceed the requirements of all applicable standards organizations for safe operation. However, as with any electrical equipment, the best way to ensure safe operation is to read this manual carefully before performing any type of connection to the handy terminal and operate them according to the agency guidelines described in the manual.

2.1. General Safety Rules



CAUTION

- Use only the components supplied by the manufacturer for the specific PM60 being used.
- Do not attempt to disassemble the PM60 handy terminal, as it does not contain parts that can be repaired by the user. Any tampering will invalidate the warranty.
- When replacing the battery pack or at the end of the operative life of the PM60 handy terminal, disposal must be performed in compliance with the laws in force in your country.
- Before using the devices and the battery packs, read this manual carefully.
- Do not submerge the PM60 handy terminal in liquid products.

CAUTION

ATTENTION

Utilisez uniquement les composants fournis par le fabricant pour l'utilisation du PM60.

Ne tentez pas de démonter le PM60. Ce produit ne contient aucune pièce ne pouvant être réparée par l'utilisateur. Toute manipulation fera perdre la garantie au produit.

Lors du remplacement de la batterie ou en fin de vie du terminal portatif PM60, l'élimination et le recyclage doit être effectuée en conformité avec les lois en vigueur dans votre pays.

Avant d'utiliser les appareils et les batteries, lire attentivement ce manuel.

Ne pas plonger le PM60 dans des produits liquides.

2.2. Power Supply

The power supply for this device has met applicable KCC/CCC safety requirements.

Please adhere to the following safety instructions per UL guidelines:

- FAILURE TO FOLLOW THE INSTRUCTIONS OUTLINED MAY LEAD TO SERIOUS PERSONAL INJURY AND POSSIBLE PROPERTY DAMAGE.
- IMPORTANT SAFETY INSTRUCTIONS – SAVE THESE INSTRUCTIONS.

WARNING

- DANGER – TO REDUCE THE RISK OF FIRE OR ELECTRIC SHOCK, CAREFULLY FOLLOW THESE INSTRUCTIONS.

WARNING **AVERTISSEMENT**

DANGER - POUR RÉDUIRE LES RISQUES D'INCENDIE OU DE CHOC ÉLECTRIQUE, VEUILLEZ SUIVRE ATTENTIVEMENT CES INSTRUCTIONS.

Use only Pointmobile-approved power supply. Use of a non-Pointmobile-approved power supply may be dangerous and the warranty does not cover damage to the device caused by non-Pointmobile-approved power supply. The package includes international AC plugs. The AC plugs must be plugged in the power supply before the power supply itself is plugged on the wall outlet. The power supply is intended to be correctly oriented in a vertical or horizontal or floor mount position.

N'utilisez que l'alimentation fournie et approuvée par Pointmobile. L'utilisation de toute autre alimentation peut être dangereuse. La garantie ne couvre pas les dommages causés à l'appareil par une autre alimentation que celle fournie par Pointmobile. L'alimentation est livrée avec des adaptateurs AC pour les différentes prises Internationales. Ces prises adaptateur doivent être installées à l'alimentation électrique avant que cette dernière soit elle-même branchée sur la prise murale. L'alimentation est destinée à être orientée en position verticale ou horizontale.

2.3. Laser Safety

CAUTION

A Class 2 laser is safe because the blink reflex limit the exposure to no more than 0.25 seconds. It only applies to visible-light lasers (400–700 nm). Class-2 lasers are limited to 1mW continuous wave, or more if the emission time is less than 0.25 seconds or if the light is not spatially coherent. Although staring directly at the laser beam momentarily causes no known biological damage, avoid staring at the beam as one would with any very strong light source, such as the sun. Avoid that the laser beam hits the eye of an observer, even though reflective surfaces such as mirrors, etc.

The laser light is visible to the human eye and is emitted from the window indicated in the figure.

ATTENTION

Un laser de classe 2 reste inoffensif pour les yeux. Le réflexe de clignement de l'œil limite l'exposition à 0,25 secondes au plus. Ceci s'applique uniquement aux lasers de lumière visible (400-700 nm). Les Lasers de Classe 2 sont limités à 1 mW (onde continue), ou davantage si le temps d'émission est inférieur à 0,25 secondes ou encore si la lumière n'est pas cohérente dans l'espace. Bien que le fait de regarder directement le faisceau laser ne cause pas de dommage biologique momentané, il est conseillé d'éviter de regarder le faisceau ainsi que n'importe quelle source de lumière très forte, comme le soleil. Évitez également que le faisceau laser frappe l'œil d'un observateur, ainsi que toutes surfaces réfléchissantes environnantes, telles que des miroirs, etc. La lumière laser est visible pour l'œil humain et est émise à partir de la fenêtre indiquée sur la figure.

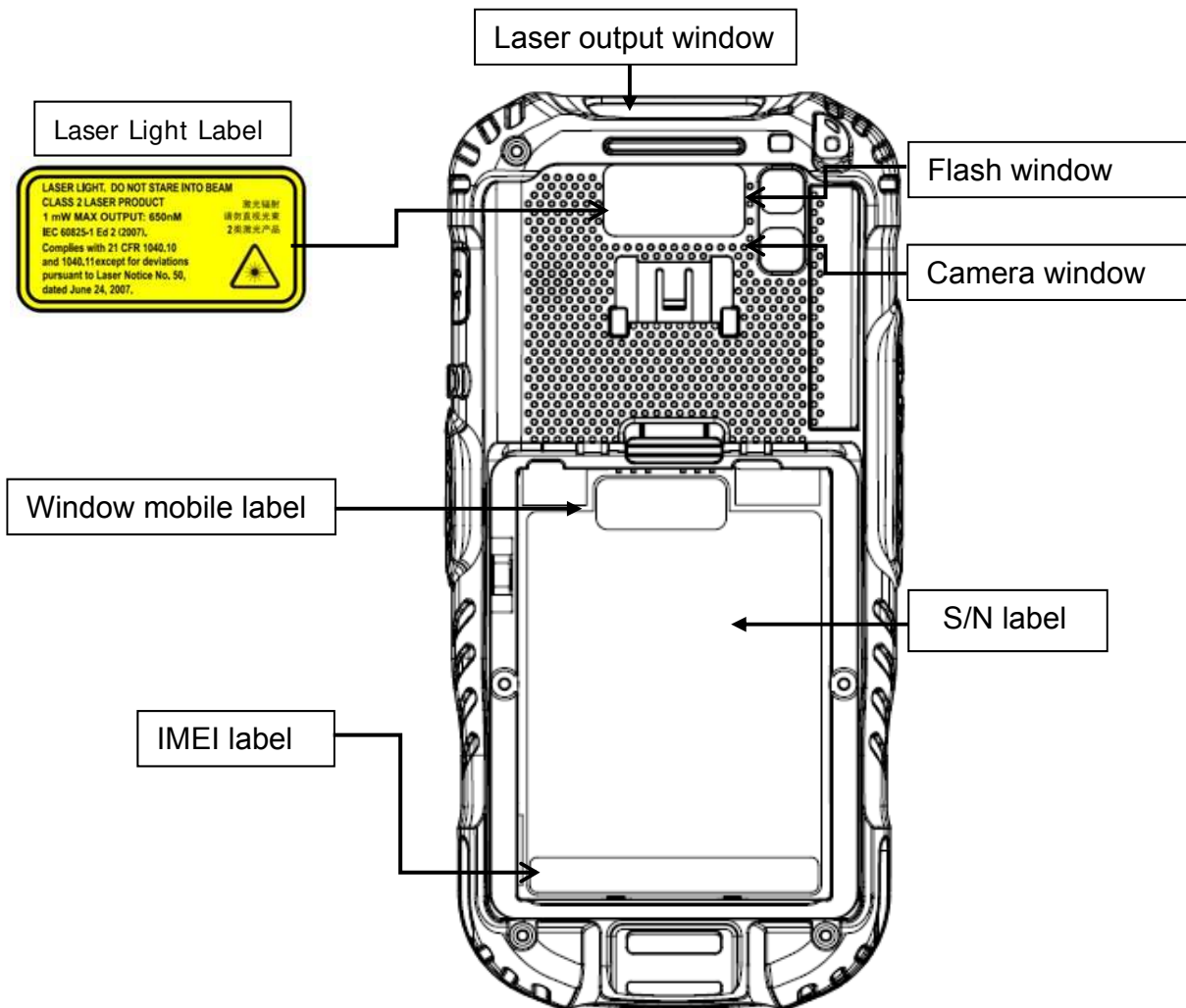

If the above laser light label is attached to your device, it indicates the product contains a laser engine or laser aimer that emits the laser light. The following information is provided to comply with the rules imposed by international authorities and refers to the correct use of PM60 handy terminal.

Laser Safety Statement

This product has been tested in accordance with and complies with CDRH 21 CFR 1040.10 and 1040.11 and IEC 60825-1 Ed 2 (2007) except for deviations pursuant to Laser Notice No 50, dated June 24, 2007.

LASER LIGHT. DO NOT STARE INTO BEAM. CLASS 2 LASER PRODUCTS. 1 mW MAX OUTPUT: 650nm.
For installation, use and maintenance, it is not necessary to open the device.



WARNING: Do not attempt to open or otherwise service any components in the optics cavity. Opening or servicing any part of the optics cavity by unauthorized personnel may violate laser safety regulations. The optics system is a factory only repair item.

AVERTISSEMENT : Ne tentez pas d'ouvrir ou d'intervenir de quelque manière que ce soit sur les composants de la cavité optique. L'ouverture ou l'entretien d'une partie de la cavité optique par des personnes non autorisées pourrait enfreindre les réglementations liées aux normes de sécurité laser. La réparation du système optique ne peut être prise en charge que par le personnel qualifié du fabricant.



WARNING: Use of controls or adjustments or performance of procedures other than those specified herein may result in exposure to hazardous visible laser light.

AVERTISSEMENT : Toute manipulation, réglage, ou l'exécution des procédures autres que ceux spécifiés ici peuvent entraîner une exposition dangereuse à la lumière visible du laser.



WARNING: Use of optical systems with the scanner will increase eye hazard. Optical instruments include binoculars, microscopes, eye glasses and magnifying glasses.

AVERTISSEMENT : L'utilisation du scanner avec des systèmes optiques tels que jumelles, microscopes, lunettes de vue et autres loupes, augmente les risques de dommages pour les yeux.

2.4. LED Safety

The LED output on this device has met IEC62471 LED safety and certified to be under the limits of a CLASS 1 LED product.

2.5. FCC/ EU RF Exposure

This device complies with FCC/EU RF exposure guidelines set forth for an uncontrolled environment. For body worn operation, this device has been tested and meets the RF exposure guidelines for use with an accessory that contains no metal and the positions the handset a minimum of 1.5 cm from the body. Use of other enhancements may not ensure compliance with RF exposure guidelines. If you do not use a body-worn accessory and are not holding the device at the ear, position the handset a minimum of 1.5 cm from your body when the device is switched on.

2.6. CB Scheme

This device complies with CB Scheme IEC 60950-1

2.7. FCC Part 15 Regulation

Pursuant to part 15 of the FCC Rules, you are cautioned that changes or modifications not expressly approved by Pointmobile could void your authority to operate the PM60 handy terminal.

This device complies with part 15 of the FCC Rules. Operation is subject to the following two conditions: (1) This device may not cause harmful interference, and (2) this device must accept any interference received, including interference that may cause undesired operation.

This device has been tested and found to comply with the limits for a Class B digital device, pursuant to Part 15 of the FCC Rules. These limits are designed to provide reasonable protection against harmful interference

in a residential installation. This equipment generates uses and can radiate radio frequency energy and, if not installed and used in accordance with the instructions, may cause harmful interference to radio communications. However, there is no guarantee that interference will not occur in a particular installation. If this equipment does cause harmful interference to radio or television reception, which can be determined by turning the equipment off and on, the user is encouraged to try to correct the interference by one or more of the following measures:

- Reorient or relocate the receiving antenna.
- Increase the separation between the equipment and receiver.
- Connect the equipment into an outlet on a circuit different from that to which the receiver is connected.
- Consult the dealer or an experienced radio/TV technician for help.

In accordance with FCC 15.21, changes or modifications not expressly approved by the party responsible for compliance could void the user's authority to operate the equipment.

The antenna(s) must not be co-located or operating in conjunction with any other antenna or transmitter. To maintain compliance with FCC/EU RF exposure guidelines for body-worn operation, do not use accessories that contain metallic components. .

2.8. Radio Compliance

PM60 RF terminals are in conformity with all essential requirements of the R&TTE Directive (1999/5/EC).

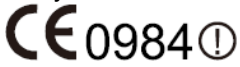
This device is marked with  in accordance with the Class II product requirements specified in the R&TTE Directive, 1999/5/EC. The device is intended for use throughout the European Community; PAN European Frequency Range: 2.402 ~ 2.480 GHz.

Restrictions for use in France are as follows:

- Indoor use: maximum power (EIRP*) of 100 mW for the entire 2.400 ~ 2.4835 GHz
- Outdoor use: Maximum power (EIRP*) of 100 mW for the 2.400 ~ 2.454 GHz band and maximum power (EIRP*) of 10 mW for the 2.454 ~ 2.483 GHz band.

 The CE mark on the device indicates that the system has been tested to and confirm with the provisions noted within the 2004/108/EC Electromagnetic Compatibility Directive and the 2006/95/EC Low Voltage Directive, 1999/5/EC (R&TTE), and 2011/65/EU (RoHS).

Pointmobile shall not be responsible for use of our product with equipment (i.e., power supplies, personal computers, etc.) that is not CE marked and does not comply with the Low Voltage Directive.

2.9. WWAN

In radio systems configured with mobile computers and access points, the frequencies to be used must be allowed by the spectrum authorities of the specific country in which the installation takes place. Be absolutely sure that the system frequencies are correctly set to be compliant with the spectrum requirements of the country. The Radio modules used in this product automatically adapt to the frequencies set by the system

and do not require any parameter settings .The TYPE field shows the correspondence between PM60 types and radio modules:

HSPA+

HSPA+, or Evolved High-Speed Packet Access, is a technical standard for wireless, broadband telecommunication. HSPA+ enhances the widely used WCDMA (UMTS) based 3G networks with higher speeds for the end user.

2.10. WEEE Compliance

Information for the user in accordance with the European Commission Directive 2012/ 19/ EU of the European Parliament and of the Council of 4 July 2012 on Waste Electrical and Electronic Equipment (WEEE)

This product has required the extraction and use of natural resources for its production. It may contain hazardous substances that could impact health and the environment, if not properly disposed. In order to avoid the dissemination of those substances in our environment and diminish the pressure on the natural resources, we encourage you to reuse, recycle and recover the product. If the product is disposed according to the Directive, it will avoid potentially negative consequences to the environment and human health which otherwise could be caused by incorrect disposal.



The product marked with crossed out wheeled bin must be disposed separately from municipal waste.

For more detailed information about disposal, reuse, and recycle system, contact your local or regional waste administration.

3. Getting Started

3.1. Install the Battery

The HANDY TERMINAL is shipped with the battery packaged separate from the unit. Follow the steps below to install the battery.

1. Remove the battery compartment door by moving the Battery door's locks up.

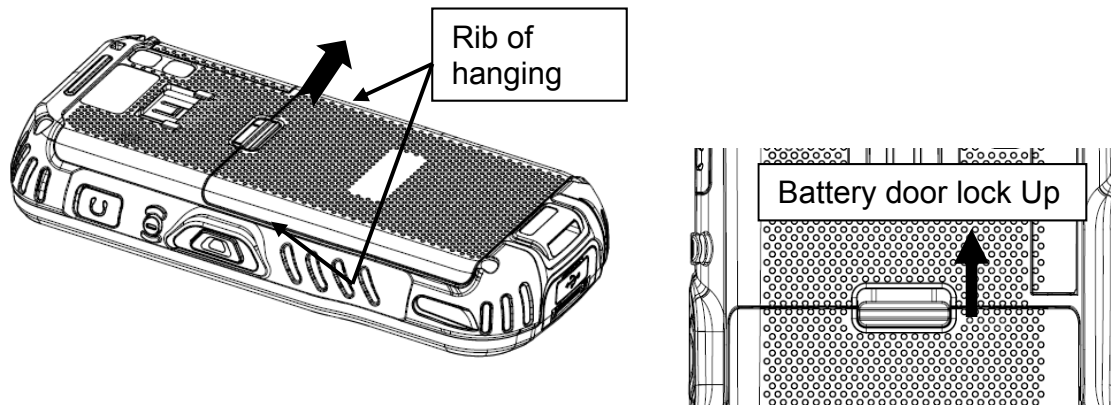

2. Insert the battery well with the battery cells facing top.

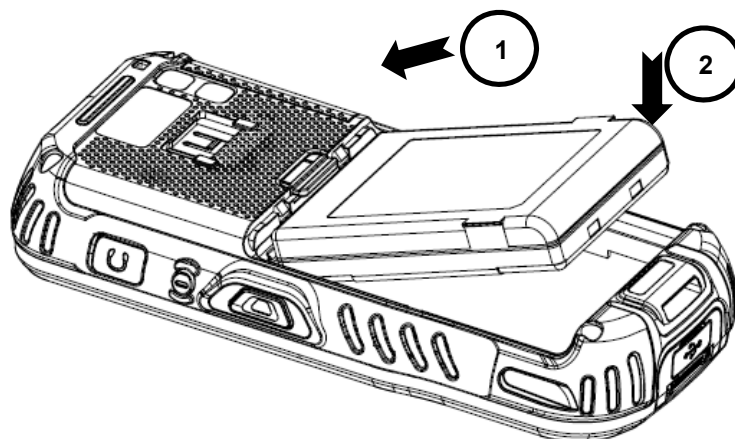

3. Replace the battery door to start from bottom to top door's lock downwards.

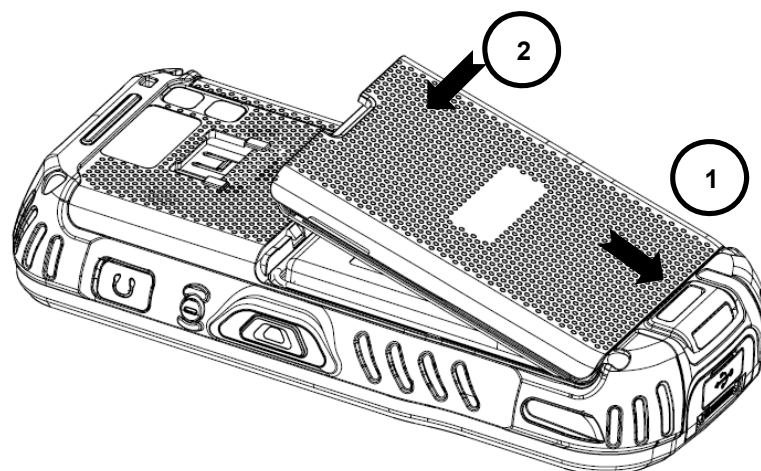

NOTE: Two points of Battery guide stopper must be pertinently inserted to rear cover battery guide stopper hole

NOTE: The battery door must be installed prior to booting the unit.

WARNING: Use only Pointmobile-approved Li-Ion battery packs. Unauthorized battery may result in damage not covered by the warranty.

AVERTISSEMENT: Utilisez uniquement des batteries Lithium-Ion approuvés par Pointmobile. Toute autre batterie peut entraîner des dommages non couverts par la garantie.

3.2. Charge the Batteries

Handy Terminals ship with only main battery pack significantly charged of power. Charge the main battery pack with the Handy Terminal charging cable for **a minimum of 4 or 6 hours depending on your battery before initial use.**

1. Attach the appropriate plug adapter to the plug of the power cable.
 2. Insert the plug into the appropriate power source.
- Plug the Handy Terminal power cable into the USB Jack on the side end of the unit.

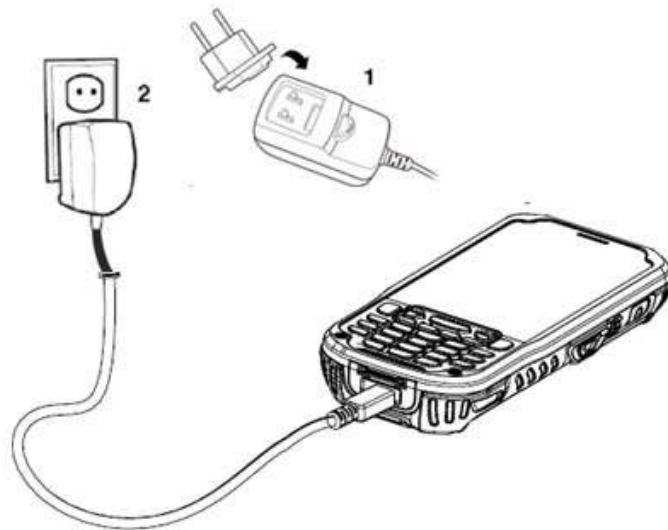

WARNING: Use only Pointmobile-approved peripherals, power cables, and power adapters. Unauthorized peripherals, cables, or power adapters may cause batteries to explode or damage your device. **DO NOT** attempt to charge damp/wet handy terminals or batteries. All components must be dry before connecting to an external power source.

Batteries must be charged at a temperature ranging from **0~45°C (±3°C)**. If you don't follow the guide, it might have a harmful effect on the battery life.

AVERTISSEMENT: Veillez à n'utiliser que les périphériques approuvés par Pointmobile (câbles d'alimentation et adaptateurs électriques). Tout périphérique non autorisé (câble ou adaptateur) peut provoquer l'explosion de la batterie ou endommager votre appareil.

NE PAS tenter de recharger les terminaux ou les batteries encore humides lorsqu'ils ont été mouillés. Tous les composants

doivent être impérativement séchés avant la connexion à une source d'alimentation externe.

Les batteries doivent être chargées à une température allant de 0~ 45°C (± 3°C). Le non-respect de ces recommandations pourrait avoir un effet néfaste sur la durée de vie de la batterie.



CAUTION: *After the battery has been charged, disconnect the DC Power Jack from the terminal. If you stay on that plug in use, it is possible to break the power code.*

ATTENTION: *Après une période de charge de la batterie, veuillez à débrancher le connecteur du chargeur. Une utilisation prolongée de celui-ci risquerait d'endommager le cordon d'alimentation.*

NOTE: *Rechargeable battery packs are not initially charged. Therefore the first operation to perform is to charge them.*

NOTE: *If you remove the battery pack or it completely discharges, you have 30 minute window of time to insert a charged battery pack before the battery completely discharges.*

3.3. LED Indicators

The red LED is ON while charging the battery and the green LED is ON when the battery is fully charged.

Alternatively, it is also possible to recharge the battery pack by using the single slot cradle, the single Ethernet cradle or the 4-slot battery charger.

During the charging process the LED positioned at the upper side of the display is red constant. Once the charging process has been completed this LED is green constant.

If the battery pack is removed from the handy terminal, it can be recharged by inserting it into the rear slot of the single slot cradle, the single Ethernet cradle or the 4-slot battery charger.

3.4. Guidelines for Battery Pack Use and Disposal

The following are general guidelines for the safe use and disposal of batteries:

- Store the terminal and the spare batteries between 20 to 30 °C (68 to 86 °F) in order to maintain optimal battery performance.
- Standard batteries must be charged at a temperature ranging from 0 to 45°C (±3°C).
- The battery level may not be displayed correctly for some minutes after the disconnection if the handy terminal is disconnected from power supply before the charging cycle is completed.
- The handy terminal could get warm during charging. This is normal and does not mean a malfunction.
- To achieve the best battery life, turn off the radios not in use.
- Rechargeable battery packs is not initially charged. Therefore the initial operation to perform is to charge them. See below.
- By default, the battery pack is disconnected at the factory to avoid damage due to excessive draining. Annual replacement of rechargeable battery pack avoids possible risks or abnormalities and ensures maximum performance.



WARNING: DO NOT attempt to charge damp/wet handy terminals or batteries. All components must be dry before connecting to an external power source.

AVERTISSEMENT: NE PAS tenter de recharger les terminaux ou les batteries encore humides lorsqu'ils ont été mouillés. Tous les composants doivent être impérativement séchés avant la connexion à une source d'alimentation externe.



WARNING: Never throw a used battery in the trash. It contains heavy metals and should be recycled according to local guidelines.

AVERTISSEMENT: Ne jetez pas une batterie usagée à la poubelle. Elle contient des métaux lourds et doit être recyclée conformément aux directives locales.



WARNING: Storage of batteries for long time at fully charged status or at fully discharged status should be avoided. Only in case of long storage, in order to avoid deep discharge of the battery, it's recommended to partially recharge the battery every two-three months to keep the charge status at a medium level.

AVERTISSEMENT: Le stockage des batteries (à pleine charge ou complètement déchargée) pendant de longues durées doit être évité.

Pour éviter une décharge profonde de la batterie en cas de stockage de longue durée ; il est recommandé de recharger partiellement la batterie tous les deux à trois mois pour maintenir l'état de charge à un niveau moyen.



WARNING: Installing, charging and/or any other action should be done by authorized personnel and following this manual.

The battery pack may get hot, explode, ignite, and/or cause serious injury if exposed to abusive conditions.

If the battery pack is replaced with an improper type, there is risk of explosion.

Do not place the battery pack in or near a fire or heat; do not place the battery pack in direct sunlight, or use or store the battery pack inside unventilated areas in hot weather; do not place the battery pack in microwave ovens, dryer, high pressure containers, on induction cookware or similar device. Doing so may cause the battery pack to generate heat, explode or ignite. Using the battery pack in this manner may also result in a loss of performance and a shortened life expectancy.

Use only a Pointmobile approved power supply. The use of an alternative power supply will void the product warranty, may cause product damage and may cause heat, explode or ignite.

The area in which the units are charged should be clear of debris and combustible materials or chemicals.

Do not use the battery pack in any other manner outside its intended use in Handy Terminal and peripherals.

AVERTISSEMENT: L'installation, la charge et/ou de toute autre action doit être effectuée par du personnel autorisé après lecture de ce manuel.

En cas d'utilisation dans des conditions abusives, la batterie peut chauffer, exploser, s'enflammer et/ou causer des blessures graves.

L'utilisation d'une batterie inappropriée peut résulter un risque d'explosion

N'exposez pas la batterie au feu ou près d'une source de chaleur; ne placez pas la batterie en plein soleil.

Par temps chaud, n'utilisez ou ne stockez pas la batterie dans des zones non ventilées.

Ne placez pas la batterie dans un four à micro-ondes, un sèche-linge, un conteneur à haute pression, sur une batterie de cuisine à induction ou tout dispositif similaire. La batterie pourrait chauffer, exploser, s'enflammer ou entraîner une perte de performance avec pour conséquence une espérance de vie réduite.

N'utilisez que le bloc alimentation fourni et approuvé par Pointmobile. L'utilisation de tout autre alimentation pourrait engendrer des dommages au produit et provoquer une surchauffe, allant jusqu'à l'explosion ou l'enflamment, et causer la perte de la garantie.

Le local dans lequel les terminaux sont rechargés doit être propre et sans aucune présence de matériaux combustibles ou de produits chimiques.

Ne pas utiliser la batterie en dehors de l'utilisation prévue pour le terminal portable.

WARNING

Do not short-circuit the battery pack contacts connecting the positive terminal and negative terminal. This might happen, for example, when you carry a spare battery pack in your pocket or purse; accidental short-circuiting can occur when a metallic object such as a coin, clip, or pen causes direct connection of the contacts of the battery pack (these look like metal strips on the battery pack). Short-circuiting the terminals may damage the battery pack or the connecting object.

Do not apply voltages to the battery pack contacts.

Do not pierce the battery pack with nails, strike it with a hammer, step on it or otherwise subject it to strong impacts or shocks.

Do not disassemble or modify (i.e. bend, crush or deform) the battery pack. The battery pack contains safety and protection devices, which, if damaged, may cause the battery pack to generate heat, explode or ignite.

In case of leakage of liquid from the battery, avoid contact with liquid the skin or eyes. If the contact occurs, immediately wash the affected area with water and consult a doctor.

Do not solder directly onto the battery pack.

Do not expose the battery pack to liquids.

Avoid any knocks or excessive vibrations. If the device or the battery is dropped, especially on a hard surface, you should take it to the nearest Authorised Repair Centre for inspection before continuing to use it.

Do not replace the battery pack when the device is turned on.

Do not remove or damage the battery pack's label.

Do not use the battery pack if it is damaged in any part.

Battery pack usage by children should be supervised.

Collect and recycle waste batteries separately from the device in comply with European Directive 2006/66/EC, 2011/65/EU, 2012/19/EU and subsequent modifications, US and China regulatory and others laws and regulations about environment.

AVERTISSEMENT : Ne mettez pas les contacts de batterie en court-circuit en connectant la borne positive et la borne négative. Cela peut se produire, par exemple, lors du transport d'un pack de batterie de rechange dans votre poche ou un sac. Un court-circuit accidentel peut se produire si un objet métallique provoque la connexion directe des contacts de la batterie. Un court-circuit risque d'endommager la batterie ou l'élément de connexion.

Ne pas appliquer de tension sur les contacts de batterie.

Ne pas percer la batterie avec des objets pointus, la soumettre à l'écrasement ou à des chocs violents.

Ne pas démonter ou modifier la batterie (en la pliant, l'écrasant ou la déformant). Celle-ci contient des dispositifs de sécurité et de protection, qui, s'ils sont endommagés, peuvent entraîner un échauffement excessif allant jusqu'à provoquer, son explosion ou son enflammement.

En cas de fuite du liquide contenu dans la batterie, évitez tout contact sur la peau ou les yeux. Si toutefois un contact se produit, lavez immédiatement la zone affectée avec de l'eau et consultez un médecin.

Ne pas souder directement sur la batterie.

Ne pas exposer la batterie à des liquides.

Éviter les chocs et les vibrations excessives. En cas de chute du terminal ou de sa batterie, en particulier sur une surface dure, il est instamment demandé de contacter le centre de réparation agréé le plus proche pour inspection et vérification de son état normal de fonctionnement.

Ne pas remplacer la batterie lorsque l'appareil est allumé.

Ne pas retirer ou endommager l'étiquette de la batterie.

Ne pas utiliser la batterie si elle est endommagée d'aucune manière que ce soit.

L'utilisation d'une batterie rechargeable par des enfants doit être supervisée par un adulte.

La Collecte et le recyclage des piles et batteries doit être faite en conformité avec la directive européenne 2006/66 / CE 2011/65 / UE 2012/19 / UE et ses modifications ultérieures. Elle doit également répondre aux lois et réglementations sur l'environnement, en vigueur aux Etats-Unis et en Chine

 **NOTE:** *In order to guarantee an adequate operating autonomy, when replacing the battery pack the handy terminal checks the battery energy level. If the battery is not sufficiently charged, handy terminal does not turn on.*

In this case, either substitute the battery pack with a charged one (sufficiently charged) or insert handy terminal into a powered cradle or plug it into the direct power supply.

3.5. Boot the Terminal and Access the Home Screen

The terminal begins the boot process as soon as power is applied. Do not press any buttons or attempt to remove the battery during the initial boot process.

3.5.1. The First Screen

The first time you power up the PM60 terminal, a [Make yourself at home] screen appears after the boot process is finished.

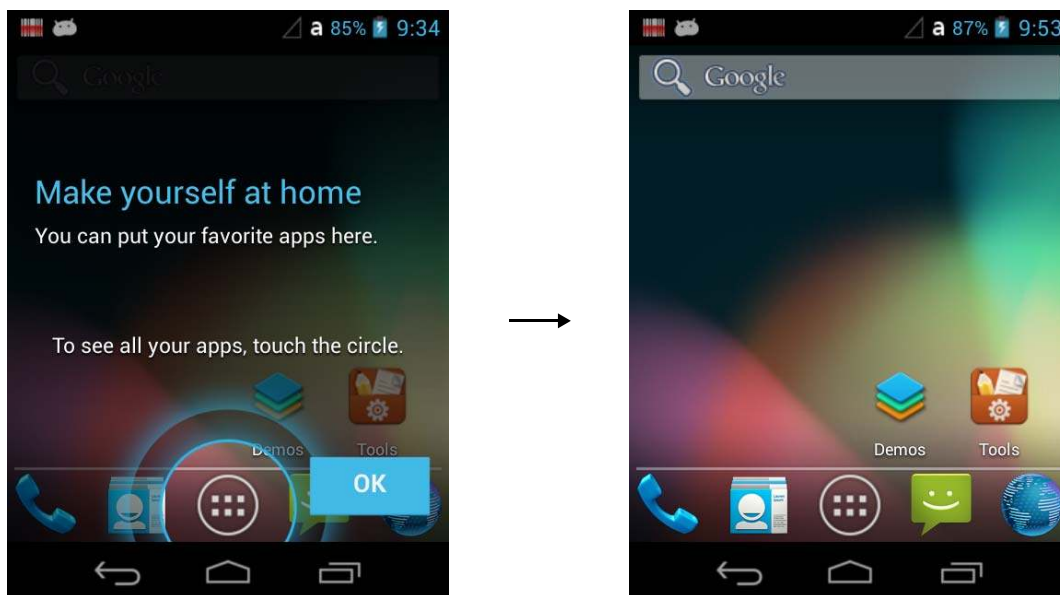

After the initial OK button is touched the Home Screen appears.

Note: Once you complete the initial [Make yourself at home] Screen, the [Make yourself at home] screen no longer appears when you reboot the device. The Locked screen displays after the terminal completes the boot process.

3.5.2. The Locked Screen

Drag the  to the any direction and access the **Home** screen.

NOTE: During the initial charging stage, the terminal may have entered **Suspend Mode** to conserve battery power. In **Suspend mode** the touch screen dims then darkens automatically after a period of no activity.

Press the **Power**  button to wake the terminal.

3.6. The Home Screen

The Android™ operating system provides space for user customization and control with five **Home Screen** panels.

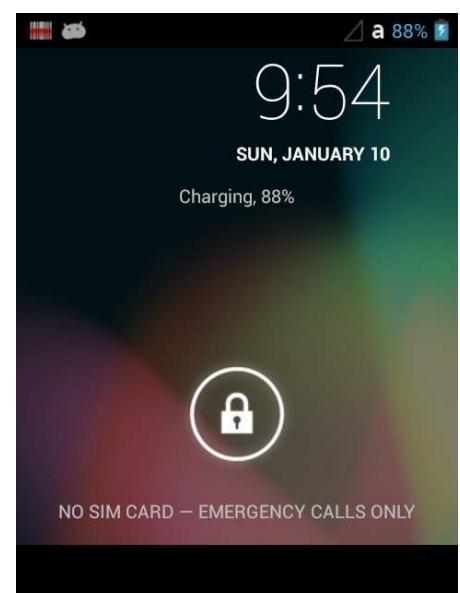

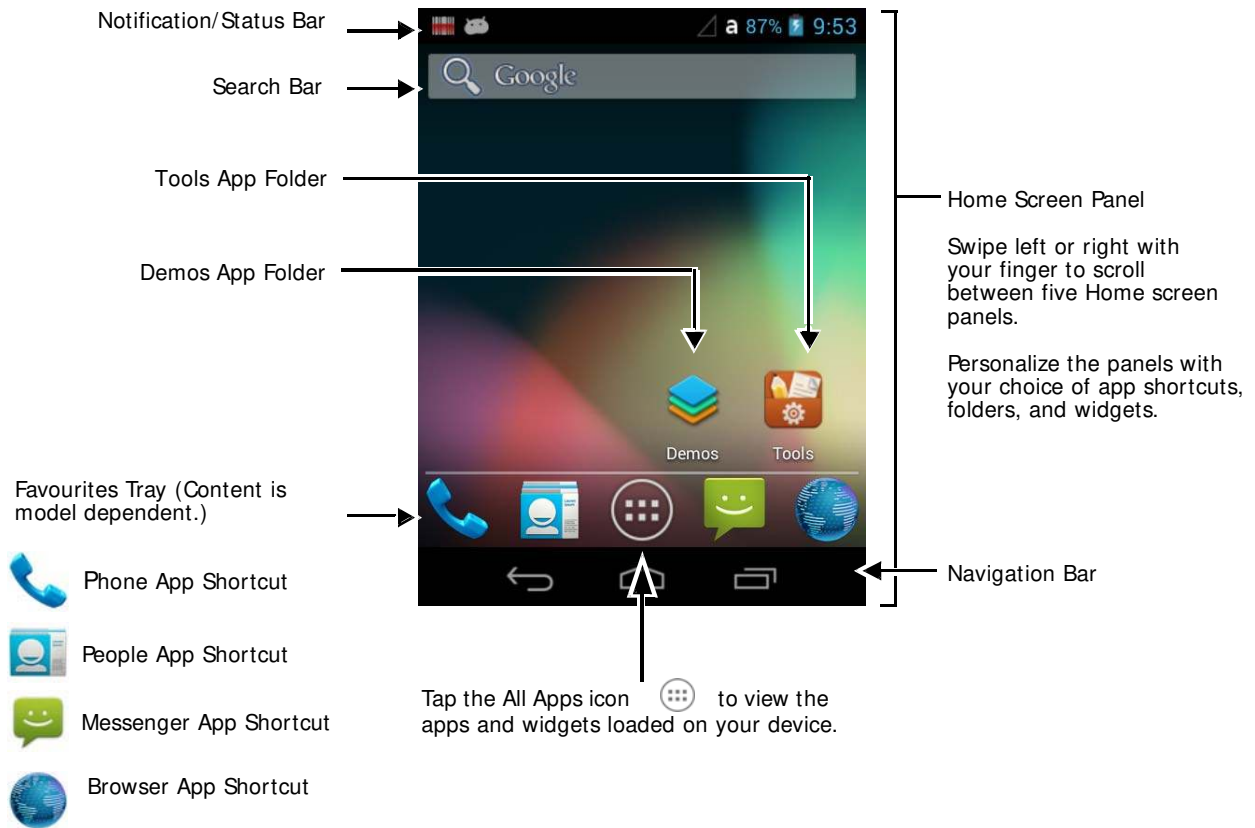

NOTE: You can return to the Home screen at any time, in any application by pressing the button.

3.6.1 Status Bar

The status bar located at the top of the touch screen displays notifications (on the left), the status of various system functions (on the right), and the current time (on the far right).

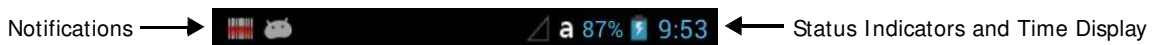

3.6.2 Notification Panel

A plus sign icon appears on the status bar when the quantity of notifications exceed the available space on the bar. To view all the notifications, touch and hold the status bar, and then drag down to open the notification panel.

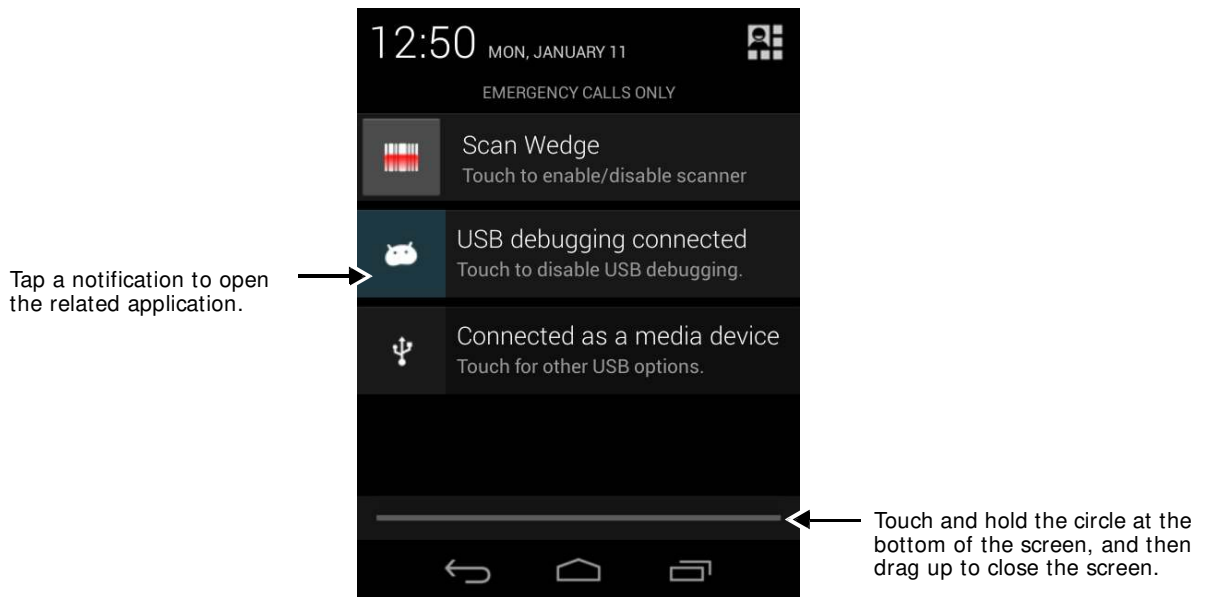

Common Status and Notification Icons

Icon	Meaning		
<i>Note: Status and notification icons are hardware and software dependent. Some of the icons listed below may not be relevant for your PM60 model.</i>			
	Open notification panel to see additional notifications		Sound is turned off
	Pending calendar event		Vibrate mode is turned on
	Pending alarm and Alarm is set		Battery charge is at 100%.
	New Hangouts™ message		Terminal is connected to external power and the battery is charging.
	New Gmail™ message		SD card or USB storage is full
	New text message or multimedia message		Bluetooth technology is turned on
	New E-mail		Terminal connected to a device with Bluetooth technology
	Error with text or multimedia message delivery		Bluetooth incoming file notification
	Terminal is connected to a computer using a USB cable		WWAN (voice & data) network signal strength
	ABD active (USB debugging enabled)		The carrier data use threshold has been reached or exceeded
	Uploading data		Wi-Fi network connected and signal strength

Icon	Meaning		
	Downloading data		Ethernet status - disconnected
	Download finished		Ethernet status - connected
	Synchronizing data		Music player active
	Error with sync or sign-in		Call in progress
	The terminal could not synchronize data with the computer		Call in progress using a headset with Bluetooth technology
	GPS is turned on		Call forwarding turned on
	Receiving location data from GPS		Call on hold
	Scanner is disabled		Missed call
	Scanner is enabled		No SIM card is installed
			New Voicemail message
			Speaker phone is on
			Call is muted





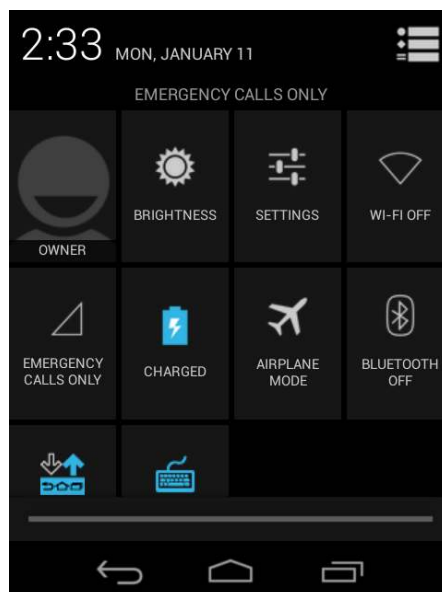



3.6.3 Quick Settings

You can set the Settings quickly. To view the **Quick Settings**, touch the  button on the top right of the **Notifications panel**.



NOTE: To view the Notifications panel touch the  button on the top right of the Quick Settings panel.

Quick Settings List

Icon	When touch		
<i>Note: Status and notification icons are hardware and software dependent. Some of the icons listed below may not be relevant for your PM60 model.</i>			
	Brightness settings is opened.		Settings is opened.
	Wi-Fi Connector is opened.		Mobile network settings is opened.
	Battery settings & information is opened		Airplane mode is enabled/disabled.
	Bluetooth Connector is opened.		Navigation bar is displayed/hidden
	Virtual keyboard is displayed/hidden.		

3.6.4 Search Bar

You can search for an item on the terminal or the Internet using **Google™ Search** at the top of any **Home** screen panel.

Touch inside the box to access the virtual keyboard for text entry.

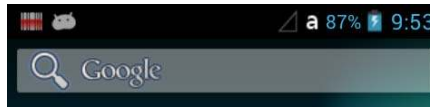

To modify the search settings:

1. Touch inside the box then press the  button.
2. Touch **Settings** then select **All, Web, Apps or People**

3.6.5 Personalize the Home Screen Panels and Favorites Tray

Streamline your work flow by customizing the **Home** screen panels and **Favorites** tray with your choice of app shortcuts, folders, and widgets.

To add an app shortcut:

1. Touch **All Apps** 
2. Select and hold the app icon you want to add. The terminal vibrates, and then switches to the home screen.
3. Drag and drop the icon into position on the **Home** screen or in an open spot on the tray. Hints:
 - To create a folder, drag and drop an app icon on top of another icon.
 - To move a shortcut from the Favorites tray to the Home screen panel, touch and hold the item, and then drag and drop the icon onto the Home screen.

To add a widget:

1. Touch **All Apps** .
2. Select the **Widget** tab.
3. Touch and hold the widget you want to add. The terminal vibrates and switches to the Home screen.
4. Drag and drop the widget into the desired position.

To remove/delete an item:

1. Touch and hold the item.
2. Drag the item to the top of the screen where the word Remove is displayed.

To move an item:

1. Tap and hold the item.
2. When the unit vibrates, drag and drop the item in the new location.

NOTE: The next panel automatically opens if you drag the item to the edge of the touchscreen.

Apps and Widgets

Touch the **All Apps** icon  located at the bottom of any **Home** screen to see the all apps and widgets loaded on your terminal.

3.7 Turning Power On/ Off

To turn the terminal **On**, Press and release the **Power** button . To turn the terminal Off:

1. Press and hold the **Power** button  until the **Phone Options** menu displays.

NOTE: If the **Show System Dialog** setting is turned off (see page 6-2), the **Phone Options** menu does not display when you press and hold the Power button. The terminal automatically reboots when Power button is held for approximately 8 seconds.

2. Touch **Power Off**.

3.7.1 Suspend Mode



Suspend mode differs from **Power off** mode. **Power off** mode is the equivalent to having no battery or external power source connected to the device. The terminal does not receive incoming calls when power is off since the device completely shuts down. In **Suspend** mode, the device enters a low power state to conserve battery power. The radio associated with the phone maintains enough power to wake the terminal for incoming phone calls. **Suspend** mode automatically turns the touch screen off and locks the terminal to save battery power when the terminal is inactive for a programmed period of time.

1. Press and release the **Power** button  to toggle the terminal in or out of **Suspend** mode.

NOTE: If the **Power key** setting has been turned off (disabled), pressing and releasing the key has no effect.

2. Drag the  to the any direction

NOTE: You should always place the terminal in **Suspend** mode before removing the battery.

To adjust the timeout limit, touch **All Apps**  > **Settings**  > **Display** > **Screen timeout**.

3.8. Using the Stylus

The terminal comes with a stylus included in a loop on the Lanyard. Use this stylus (or your finger) to select or enter information on the touch screen. The stylus functions as a mouse; generally, a tap is the same as a click.

Tap Tap the touch screen once to open menu items and select options.

Drag Hold the stylus on the screen and drag across the screen to select text and images.



Tap & hold Tap and hold the stylus on an item and a pop-up menu appears. On the pop-up menu, tap the action of the task you want to perform.





WARNING: Use of objects, such as paper clips, pencils, or ink pens on the touch screen can damage the input panel and may cause damage not covered by the warranty.



AVERTISSEMENT : L'utilisation d'objets, tels que trombones, crayons, stylos à encre sur l'écran tactile peut l'endommager et causer des dommages non couverts par la garantie.

3.9. Using File Explorer

Use File explorer to navigate through the files on your system. Tap **All Apps**  > **Tools**  > **OI File Manager**

Press the file you want for a second and delete using the Delete button  on the top of right.
Cut, Copy or Paste and set the application using Menu button  on the top of right.

To install the application:

1. Put the Application file (.apk) the storage you want
2. Tap All Apps  > Tools  > OI File Manager
3. Press the Application file (.apk) on the OI File Manager.
4. If you see the Install blocked, press the Setting button and check the checkbox of Unknown sources.
5. Please do no.2 again.
6. Try install pressing Install button.
7. If set up success, "App installed" is shown on the screen.

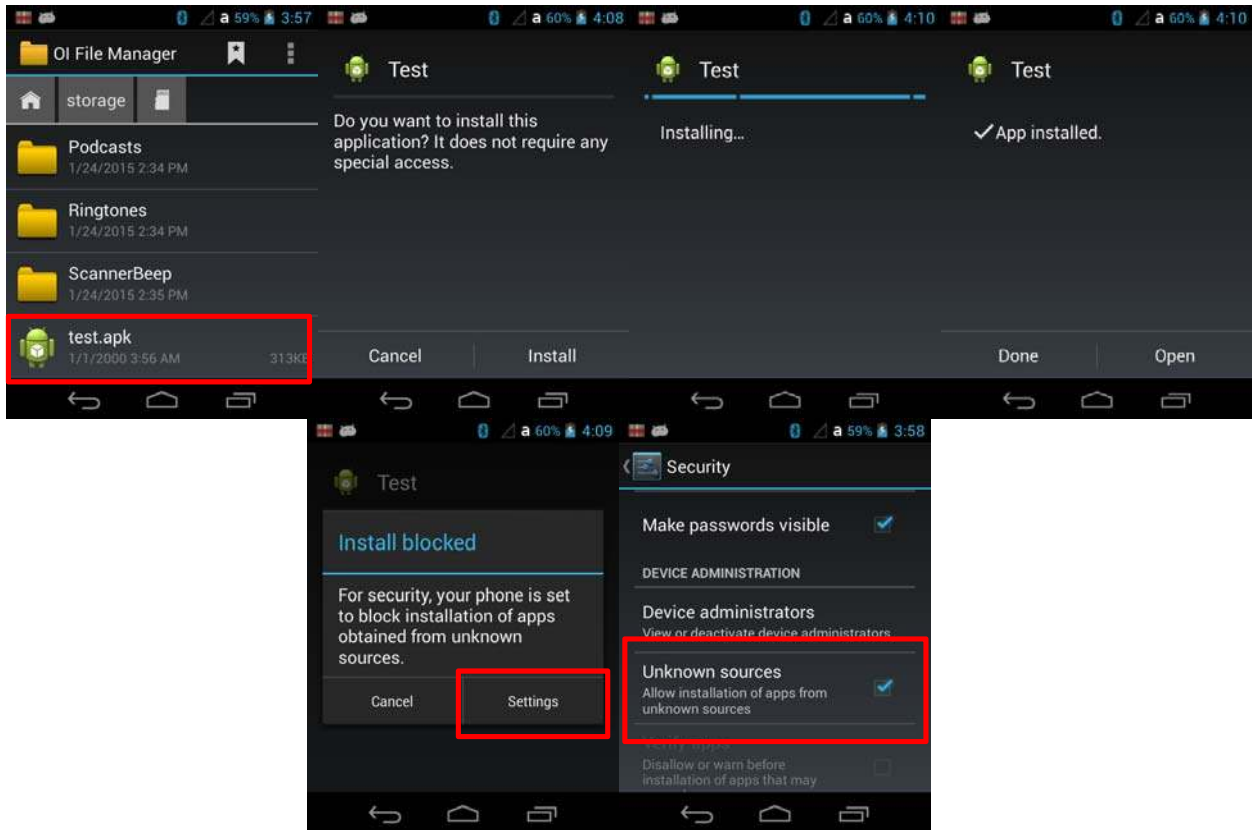

NOTE: If Settings > Security > Unknown sources is checked on the check box, please skip no. 4.5

4. Get to Know Your Device

4.1. Feature of Your Device

The following list outlines a few of the feature included in your device.

4.2. PM60 Handy Terminal

- Operating Systems: Android 4.2.2(Jelly Bean)
- Micro Processor: Cortex-A8 1GHz
- RAM Memory: 512MB
- FLASH Memory: 1GB
- 3.5" VGA Display: 480x640 Transmissive TFT
- Industrial Grade Touch Screen
- Keyboards: Numeric, Qwerty
- Micro SDHC Expansion Memory Card Interface: Support up to 32 GB
- Power Supply : MicroUSB power adaptor
- Interfaces : Micro-USB connector : USB 2.0 High Speed
- HandyLink connector: USB 2.0 High speed Client, Host (USB Host for Ethernet Cradle), Charging
- Scan Engine:

- 1D engine: N4313
- 2D engine: N560X
- Battery: Li-ion battery, 3.7V/4000mAh/14.8Wh
- IP65 certified enclosures
- Audio: Integral Microphone, Earpiece, Loud, Speaker, 3.5pi 4pole Jack for Ear-Mic headset
- BT: Bluetooth Radio 2.1+EDR with Internal Antenna
- WLAN: 802.11 b/g/n Radio with Internal Antenna
- Notification LEDs
- 1) Power indications, 2) Scan reading indications & OS notifications
- Notification Vibration Motor
- Camera : 5M pixel CMOS camera with AutoFocus and LED flash
- Sensors : Proximity sensor and Acceleration sensor
- GSM/GPRS/EDGE : Quad band, 850/900/1800/1900MHz
- UMTS/HSPA+ : Five band, 800/850/900/1900/2100MHz
- GPS: Standalone and Assisted GPS

4.3. Front Panel Layout



LED Indicator

Shows the information needed to operate your device as follows:

Note: The LED is user-programmable.

LED Color	Meaning
Red	Lights when main battery is charging. Blinks, when the battery is very low (< 10%), Lights when the battery is low (< 20%), Blinks as Red/ Green by turns when it is no battery or not recognized
Green	Lights, when the PDA resets Lights when main battery charging has completed. Blinks as Red / Green by turns when it is no battery or not recognized
Blue	Lights when a scan Pass Lights when PDA wakes up
Red	Lights when a scan fails Lights when PDA suspends
Red	Lights when main battery is charging.
Green	Lights when scanned bar code is successfully decoded. Lights when main battery charging has completed.
Blue	Lights when a scan Pass
Red	Lights when a scan fails

Keypad

32 numeric keypad (includes side scan and volume, power button).

55 qwerty keypad (includes side scan and volume, power button).

Microphone

The integrated microphone can be used for audio recording and phone call.

Touch Screen Display

The display is a LCD (Liquid Crystal Display) with a Capacity touch screen. The 3.5" VGA (Video Graphic Array) is transmissive active matrix color and backlit. The resolution is 480 x 640; see Display Backlight on paragraph 9.1.2.2.



For touch screen input, use the stylus included with the terminal or your finger. The method you choose depends on which one is most appropriate for your application. While there is a great deal of variation in different applications, you generally achieve greater accuracy with the stylus for buttons or icons that are close together.



WARNING: Use of objects, such as paper clips, pencils, or ink pens on the touch screen can damage the input panel and may cause damage not covered by the warranty.

AVERTISSEMENT : L'utilisation d'objets, tels que trombones, crayons, stylos à encre sur l'écran tactile peut l'endommager et causer des dommages non couverts par la garantie.

4.4 Display

Touch **All Apps**  > **Settings**  > **Display** from the screen to set the touch screen **Brightness** level, **Turn on keyboard backlight** on or off, **Wallpaper**, turn **Auto-rotate screen** on or off, adjust the touch **Screen timeout** settings, set the on display **Wakeup Source**, set the on screen **Font size**, and enable or disable some **Power** button  functions.

4.5 Using Screen Protectors

Pointmobile defines proper use of the terminal touch panel display as using a screen protector and proper stylus. Screen protectors maintain the ongoing integrity (i.e., prevent scratching) of the touch panel, which is why their use is recommended for applications that require a high to medium level of interface with the touch panel.

Pointmobile also mandates use of the proper stylus, which is one that has a stylus tip radius of no less than 0.8mm. Use of the stylus included with the terminal is recommended at all times.

4.6 Installing Your Screen Protector

When installing a screen protector, use a flat plastic card (e.g., credit card) to apply the screen protector smoothly and remove any air bubbles.

1. Press the Power key to put the terminal in suspend mode.
2. Clean the touch panel thoroughly with a clean, non-abrasive, lint-free cloth, Make sure nothing is on the touch panel.
3. Blue tag with backing film: Peel off this mask before application.

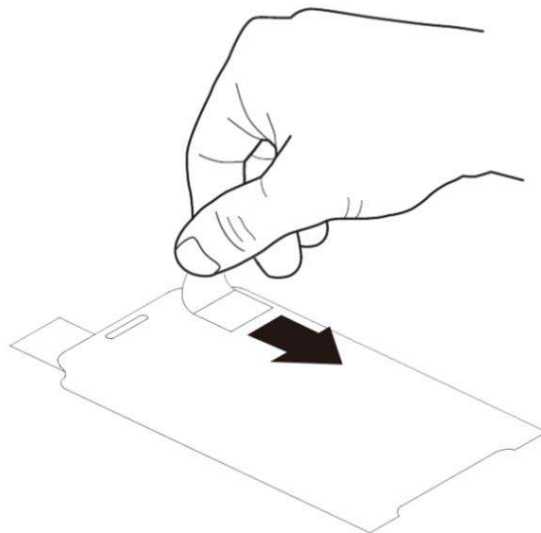

4. Align the exposed edge of the screen protector along the left edge of the touch panel. Make sure that it lies flush with edges of the touch panel.

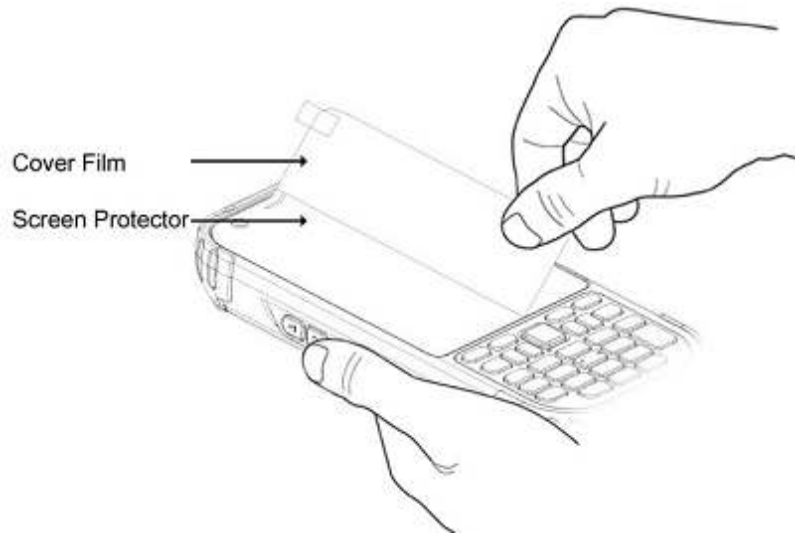

NOTE: To reposition the screen protector, lift up gently and reapply.

5. Yellow tag with cover film:
"Please peel off this mask after application completed."

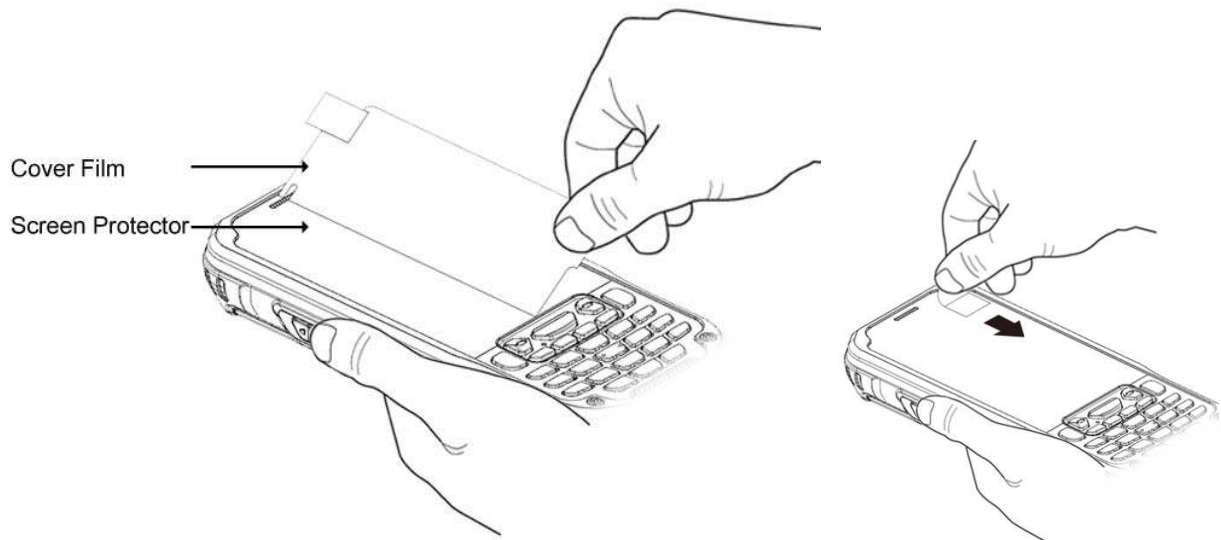

6. Press gently but firmly. Use the card a necessary to smooth out any air pockets or bumps after application

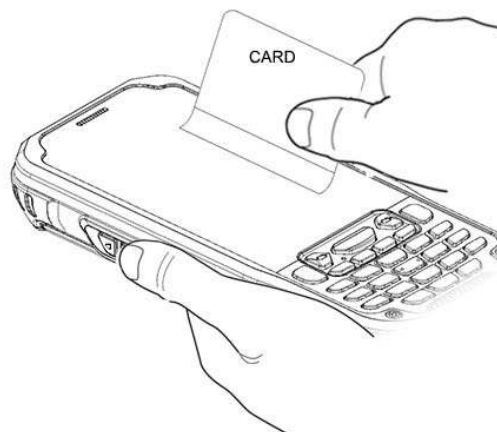

7. Press the Power key to wake the terminal and check the touch panel with the stylus.

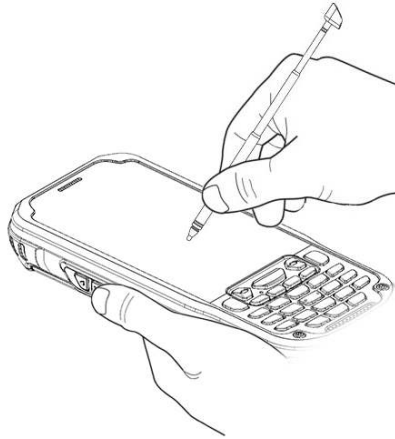

8. Verify that the screen accepts input from the stylus as usual. If not, re-apply the screen protector.

9. Press the Power key to put the terminal back in suspend mode.

10. Clean the surface of the screen protector with a clean, non-abrasive, lint-free cloth.

11. Press the Power key to wake the terminal again.

4.7 Back Panel Layout

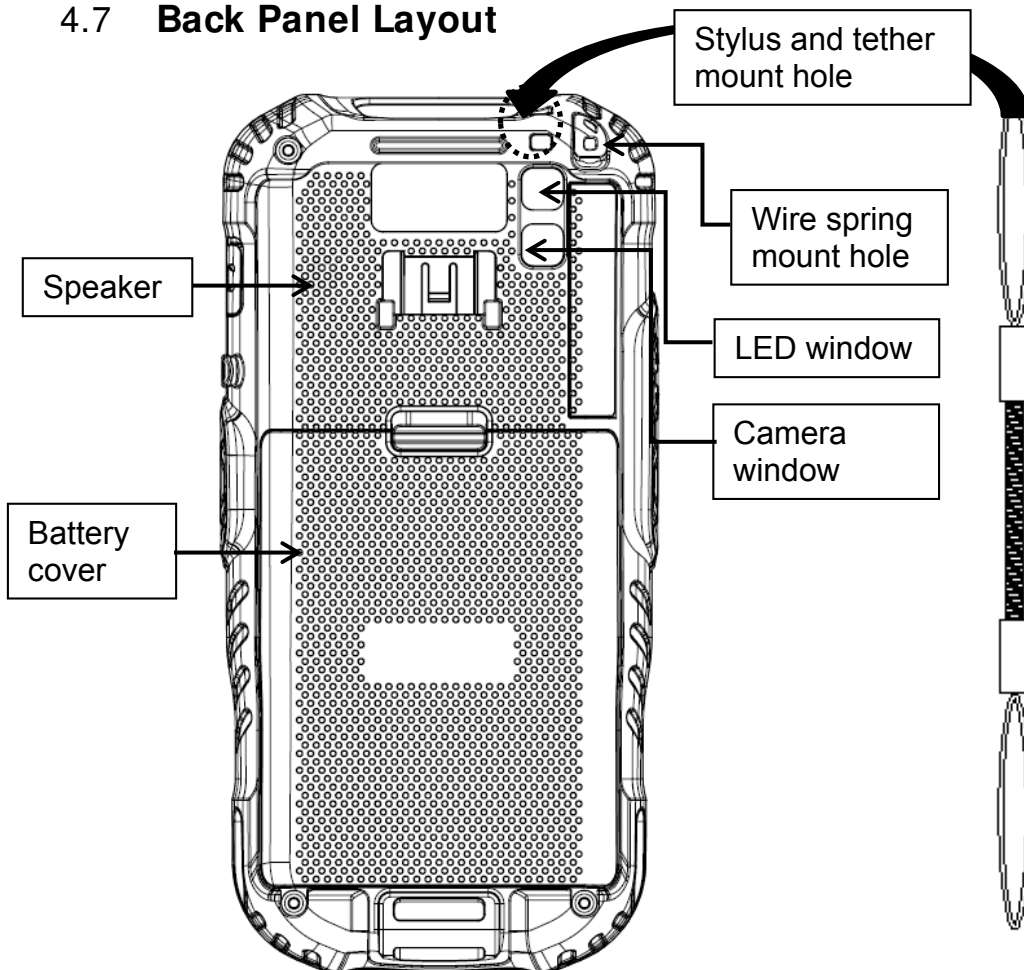

Hand strap

The HANDY TERMINAL comes with Hand strap. You can attach it to the device.

Finger Saddle

This is a slightly depressed and angled area of the back housing that is designed to cradle or “saddle” your finger while holding the terminal. This unique ergonomic design makes the terminal comfortable to hold and helps prevent you from accidentally dropping the terminal.

Installed Battery

For information about installing the battery, see Install the Battery on paragraph 3.1.

For information about battery power, see Battery Power on paragraph 4.16.

Speaker

The integrated speaker sounds audio signals as you scan bar code labels and enter data, but emits no ambient noise on system activity (i.e., processor, memory access, radio traffic, etc.). The speaker can also be used for playing sounds (e.g., WAV or MP3 files).

The speaker meets the following SPL levels at 10cm:

- 500Hz–80dB
- 1kHz–90dB
- 4kHz–90dB

Stylus and tether

HANDY TERMINAL is shipped with a stylus inserted in a loop on the tether.; see Using the Stylus on paragraph 3.8.

4.8 Left Side Panel Layout

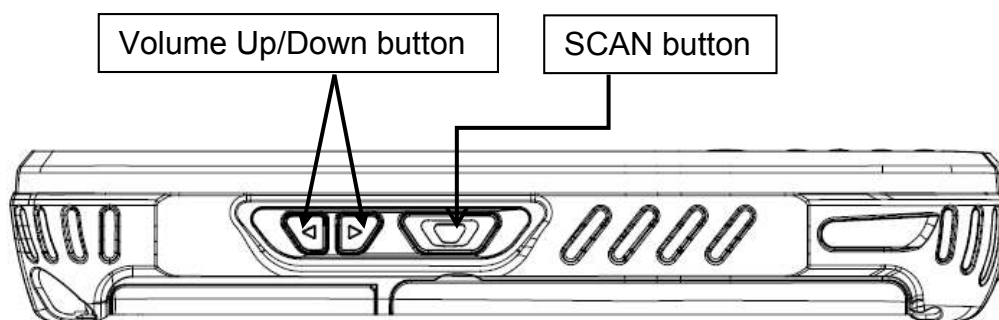

Side Button

You can set the volume using the Volume Button and scan using the Scan button.



4.9 Installing Memory Cards

The HANDY TERMINAL supports Micro Secure Digital (SD) memory cards up to 32GB. **Sandisk, Kingstone and ATP micro SD recommended**

To access the Micro SD card slot and insert the card, proceed as follows:

1. Press the **Power** key to put the terminal in Suspend Mode; see Suspend Mode on paragraph 4.20.
2. Remove the battery door on the back of the unit.
3. Remove the battery and open
4. Insert the SD card with the label facing upward.

NOTE: To remove an installed SD card tap on the edge lightly to unlock the card; the card will pop out just enough for you to grab its edge and pull it out.

5. Tap the **Power** key to resume operation.
6. To verify that the operating system recognizes the new memory card, open **All Apps**  > **Tools**  > **File Manager** and navigate to **Storage>sdcard1**.

WARNING: Follow proper ESD precautions to avoid damaging the SD. Proper ESD precautions include, but are not limited to, working on an ESD mat and ensuring that the operator is properly grounded. Do not force the card. If you feel resistance, remove the card, check the orientation, and reinsert it. Do not use the Micro SD card slot for any other accessories. It is highly recommended to lock the card holder even if the card is not present.

AVERTISSEMENT: Suivez les précautions appropriées contre les décharges électrostatiques pour éviter d'endommager la carte SD. Ces précautions comprennent, mais ne sont pas limités au travail sur un tapis de décharge électrostatique avec l'assurance que l'opérateur est correctement relié à la terre. Ne forcez pas lors de l'installation de la carte SD. Si vous sentez une résistance, retirez la carte, vérifiez son orientation et réinsérer la. Ne pas utiliser le lecteur de carte Micro SD pour d'autres accessoires. Il est fortement recommandé de verrouiller le support de carte même si la carte n'est pas présente.

4.10 Right Side Panel Layout

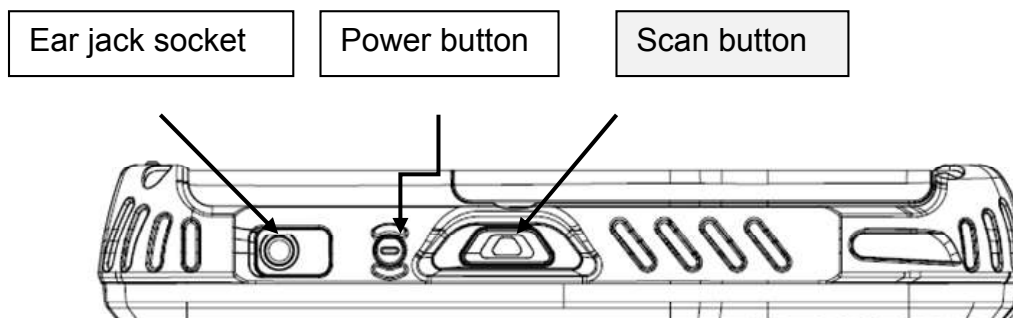

Side Button

You can use the Programs Buttons option in the Control Panel to change the functionality of the side buttons. Scan function is assigned by default (Scan button).

EarJack

3.5pi 4pole Jack. This connector supports Ear-Mic headset

4.11 Top Panel Layout

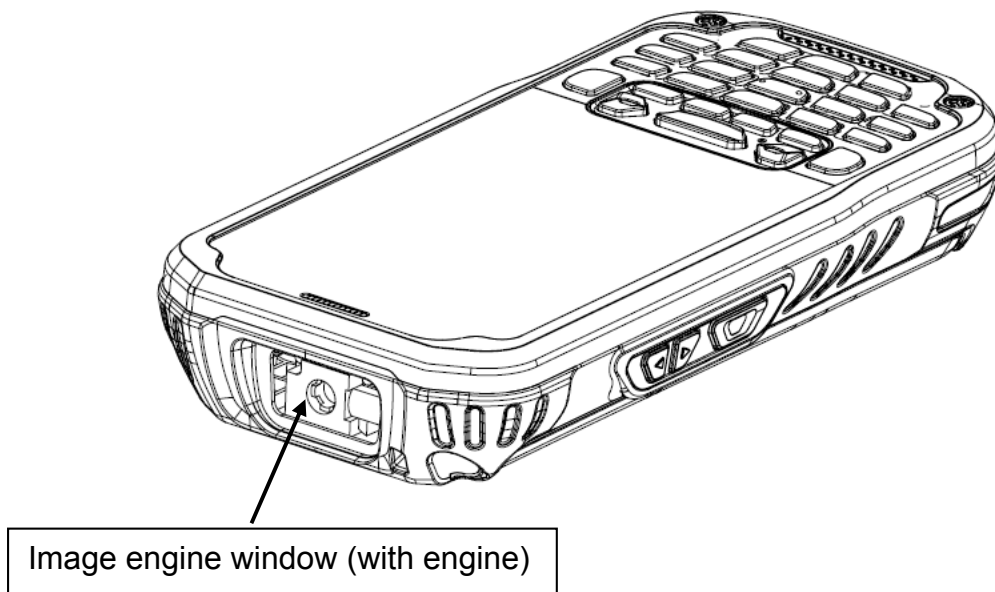
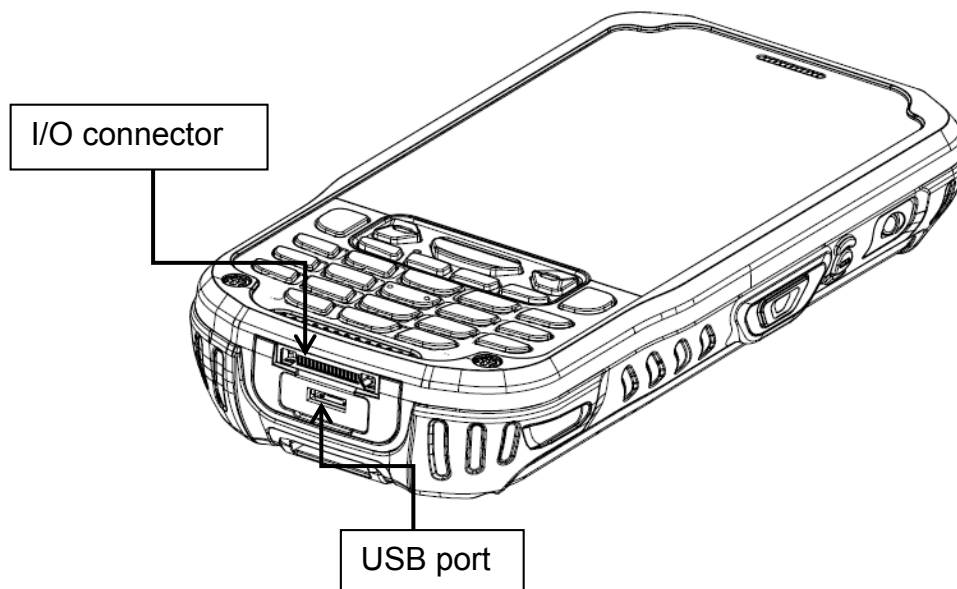

Image Engine Window

The angled image engine reads and decodes most popular bar code symbolizes. For more information, see Using the Image Engine on paragraph 6.

4.12 Bottom Panel Layout



HandyLink Connector

The HandyLink mechanical connector is designed to work exclusively with HANDY TERMINAL peripherals and cables. This connector powers the terminal, charges the main battery, and facilitates communication. This connector supports High speed USB 2.0 communication (up to 480 Mbps)

Through this connector, you can communicate with a host workstation via MTP (or PTP); see USB Communication on paragraph 10.4

The I/O connector supports the following signals:

Pin Description	Direction
DC IN +5V	IN
DC IN +5V	IN
RS-232 Transmitted Data → NC	
GND	
USB Host +5V Enable	OUT
USB Host D+	IN/OUT
USB Host D-	IN/OUT
USB Host Detect	IN
GND	
RS-232 Received Data → NC	
GND	
GND	
CRADLE Detect	IN
USB Client D+	IN/OUT
USB Client D-	IN/OUT
USB Client +5V	IN

NOTE: Signals referenced are for a DTE device.

USB Port

This connector supports High speed USB 2.0 communication (up to 480 Mbps) Also external power from the MicroUSB Adaptor that is included with the terminal. When connected to the Handy Terminal MicroUSB Adaptor, the terminal is powered and the main battery pack is charging.

4.13 Peripherals and Accessories

The following items are sold separately and enhance your HANDY TERMINAL's capabilities.

Single Slot Cradle

This charging and communication cradle supports USB communication, enabling your terminal to interface with the majority of enterprise systems. When a terminal is seated in a powered base, its battery pack charges in five hours for the standard capacity 4000mAh pack.

For more information, see Single Slot cradle/Single Ethernet cradle Device on paragraph 12.

Single Ethernet Cradle

The Single Ethernet cradle is used to charge the battery, to power the battery charging system in the terminal, and can be used to communicate data from the terminal to a PC/laptop via the Ethernet port.

For more information, see Single Slot cradle/Single Ethernet cradle Device on paragraph 12.

4.14 MicroUSB Cable

The MicroUSB cable is used when communicating between the terminal and a host computer to transfer data via the USB interface.

4.15 Li-ion Battery Packs

The Li-ion battery pack provides the main power supply for the terminal.

4.16 Battery Power

The intelligent battery technology inside the terminal features of battery power:

- The battery pack

The battery works to prevent data loss when the terminal is used over long periods of time.

The battery must be charged to full capacity before using the HANDY TERMINAL for the first time!

Charge the main battery pack with the Handy Terminal charging cable for **a minimum of 5 hours depending on your battery before initial use.**

4.17 Main Battery Pack

There are two Li-ion battery packs available for the HANDY TERMINAL:

Standard Capacity: Li-ion 3.7V/4000mAh/14.8Wh

The Li-ion battery pack is the primary power source for the Handy Terminal as well as for the internal backup battery.

Changing the Main Battery Pack

Before installing a battery pack, press the Power key to put the terminal in Suspend Mode so that operations are suspended before removing the main power source. Always put the terminal in Suspend Mode prior to changing the battery. The HANDY TERMINAL is shipped with the battery separate from the unit. You will need to loosen the tether, remove the battery door, insert the battery, and replace the battery door.

NOTE: The battery door must be installed prior to booting the unit.

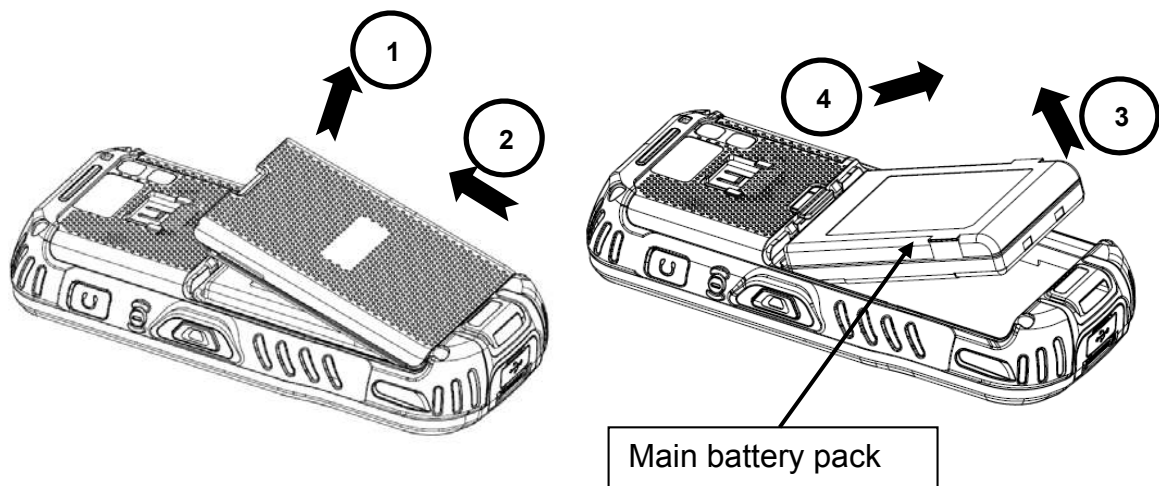

Charging Options

When the battery is installed in the terminal, you can use any of the peripherals listed below to

charge the battery.

- AC Power Supply to USB Port direct.
- Single slot docking cradle/Single slot Ethernet cradle
- Insert the battery in the spare battery charging well in the back of either the Handy Terminal slot cradle or Handy Terminal Ethernet cradle.

Charging Time

The standard capacity 4000mAh Li-ion battery pack requires five hours to charge to full capacity.

4.18 Managing Main Battery Power

Data and files saved on the Handy Terminal may be stored in RAM memory; therefore, maintain a continuous power supply to the terminal to help prevent data loss. When you remove a battery pack, insert another charged battery pack in the Handy Terminal. If the main battery pack is low, insert the terminal into a charging peripheral to power the terminal and begin recharging the battery.

NOTE: If the main battery is low and the terminal is in Suspend Mode, pressing the **Power** button does **not** wake the **HANDY TERMINAL**; you must replace the discharged battery with a fully charged battery or apply **AC power** to the terminal.

Checking Battery Power

Tap the battery icon to open the Power Properties. The Battery tab opens displaying the charge status of the main battery.

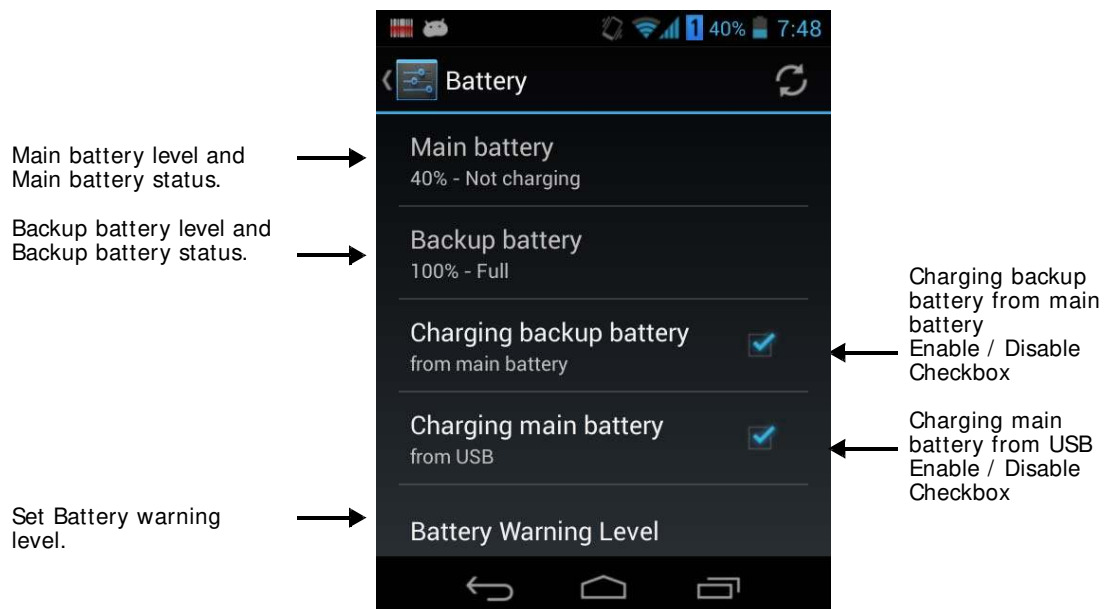

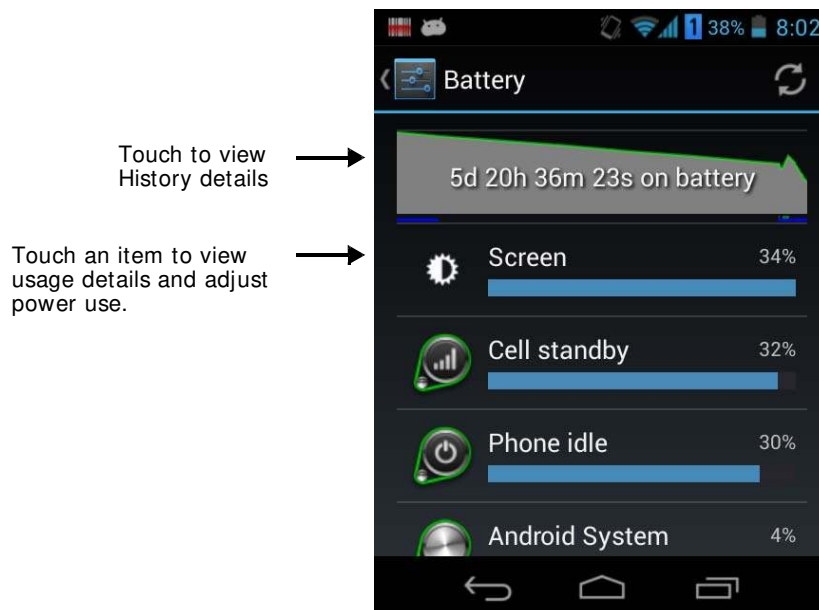

NOTE: Touch **All Apps**  > **Settings**  > **Battery** to display information the **Main battery** status and

Backup battery status (charging or discharging), the level (percentage) of charge remaining on the battery, and a breakdown of battery usage statistics for any running apps and services.

Please set up the charging the Backup Battery from Main Battery or Main Battery from USB Cable. Also set the average of alert message of Low battery level or Critical low battery level using Battery Warning Level.

4.19 Resetting the Terminal

There are three types of system resets: a Soft Reset, a Hard Reset, or a Factory Reset. The soft and hard resets preserve all data stored in the file system. Contact a technical support representative for more information on how to perform a Factory Reset.

Soft Reset (Warm Boot)

A soft reset re-boots the terminal without losing RAM data, terminates all running applications, reloads the OS, and launches Autoinstall, which re-initializes any APK files in **WAutol nstallW** folder.

You would perform a soft reset 1) when the terminal fails to respond, 2) after installing software applications that require a reboot, or 3) after making changes to certain system settings.

To perform a Soft Reset:

1. Press the Power button for 3 seconds and choose the **Reboot** on the power menu.
2. When the reset is complete, the Desktop appears.

Hard Reset (Cold Boot)



CAUTION: A hard reset erases all of the data and applications stored in RAM memory, reloads the OS, and launches Autoinstall, which installs any APK files in the **WAutol nstallW**.

ATTENTION : Une réinitialisation matérielle (hard reset) efface toutes les données et les applications stockées dans la mémoire RAM du terminal. Elle charge à nouveau le système d'exploitation, et lance la procédure d'Autoinstall, qui installe tous les fichiers APK dans le répertoire **W Autol nstall**

To Perform a Hard Reset:

1. Press and hold the Power button for 8 seconds until the terminal starts to re-boot.
2. When the reset is complete, the Desktop appears.

To perform a Hard Reset if the terminal has stopped responding, press and hold the Power button for 8 seconds until the terminal starts to re-boot.

4.20 Suspend Mode

Suspend Mode suspends terminal operation. The terminal appears to be “off” when in Suspend Mode. The terminal is programmed to go into Suspend Mode automatically when inactive for a specified period of time. You can set this time period in the Power setting.

To suspend and resume operation, press the **Power** button. You may also press the front Scan key to wake a suspended device unless the battery door has been removed and replaced.

 **NOTE:** You should always put the terminal in Suspend Mode when you change the battery pack; see [Changing the Battery Pack](#) on paragraph 4.17.

Troubleshooting Suspend/ Resume

If the terminal does not wake when you press the Power button, the main battery might be too low to resume operation. To check, remove the battery and install a fully charged battery or connect the terminal to a Handy Terminal charging peripheral.

4.21 Memory Allocation

You can verify file storage and program memory in System Properties.

1. Touch **All Apps**  > **Settings**  > **Device** > **Storage**.

4.22 Care and Cleaning of the Products

When needed, clean the image engine window and the LCD display with a clean, non-abrasive, lint-free cloth. The terminal can be cleaned with a damp cloth.

4.23 PM60 Technical Specifications

Model	PM60
Operating System	Android 4.2.2 (Jelly Bean)
Application Software	Tools and Demos
Processor	Cortex-A8 1GHz
Memory	512MB RAM X 1GB Flash
Storage Expansion	User accessible Micro SD memory card slot.
Display	3.5 in. transmissive active matrix 65K color LCD with backlight, VGA (480 x 640)

Scan Engine	1D engine: N4313 2D engine : N560x
Keypad	Numeric , Qwerty
Audio	Built-in microphone and speaker
I / O	High speed USB 2.0 from cradle (or I/O cable)
Battery	Li-ion battery 3.7V / 4000 mAh / 14.8 Wh
Expected Hours of Operation	8.5+ hours (with scan and continuously transmitting if using new standard Li-ion battery)
Charging	5V input through MicroUSB port.
Expected Charge Time	Capacity: 4000mAh – approx. 5 hours
Charging Peripherals	MicroUSB Adaptor Single Slot cradle–single-bay terminal charge/communicate Single Ethernet cradle–single-bay terminal charge/communication base (Via Ethernet connection) Quad Battery Charger
WPAN	Bluetooth Class II (10 m) v2.1 Enhanced Data Rate (EDR) with internal antenna.
WLAN	Dual Mode 802.11 b/g/n (11 Mbps/54 Mbps) with internal antenna
WLAN Security	Wi-Fi Certified, 802.1X, WPA2, EAP, WEP, LEAP, TKIP, MSD, EAP-TLS, EAP-TTLS, WPAPSK, PEAP, CCXv4
WWAN	GSM: Quad band, 850/900/1800/1900MHz UMTS/HSPA+ : Five band, 800/850/900/1900/2100MHz
GPS	Assisted GPS
Operating Temperature	-20° to 55°C
Charging Temperature	0~ 45°C (± 3°C))
Storage Temperature	-25° C to 70° C
Humidity	95% humidity, non-condensing
Construction	High impact resistant PC/ABS housings Magnesium alloy internal chassis with component shock mounts
Drop	1.22m multiple drops to concrete, MIL-STD-810G, Method 516.6, Procedure
Tumble	3.3 ft (1.0m) tumbles (500 drops)
ESD	Air: ± 15kV Direct: ± 8kV
Environmental	Independently certified to meet IP65 standards for moisture and particle resistance
Dimensions	H; 157.4mm x W; 74.2mm x L; 25.8mm(top)
Weight	1) 1D ; 330g (239g with battery) 2) 2D ; 330g (239g with battery)

Scanner / Decode Capabilities	1D Laser model: N4313 laser engine. Decodes all standard 1D codes. 2D engine model: N560X 2D Imager. Decodes all standard 1D, 2D, Postal, and OCR codes.
--------------------------------------	---

5 Using the Keypad

5.1 Numeric Keypad Layout



5.2 Navigation Keys

Located in the center of the keypad for easy access with either hand, the navigation keys enable you to move the cursor up and down lines and from character to character.

5.3 Basic Keys

Name	Function
BLUE	Modifies the next key pressed to type specific functions.
Yellow (ALPHA)	Toggles the keypad between alpha (upper and lowercase) and numeric modes. Indicator changes accordingly on the status bar.
Send	Begin dialing. Start an action.
End	Hang up. Cancels an action.
ESC	returns to closing stage of program and stage before
Tab	Moves to next control (Indent function to Text editor)
Backspace	Backspace moves the cursor back one space. If you are typing text, a character is deleted each time you press the backspace key.

Enter	Performs the same function as the Enter key on a workstation.
Power	Suspends and resumes the terminal.
Scan	Activates the image engine to scan a bar code or take an image.
Soft(Left/ Right)	Button move of Task Bar of bottom (Left/Right)

5.4 Alpha/ Numeric Modes

The keypad defaults to numeric mode. Use the ALPHA key to toggle between numeric and alpha modes.

Pressing the ALPHA key once locks the keypad in numeric mode, alpha mode (lowercase), or alpha mode (uppercase).

The status bar on the screen displays an icon that indicates the alpha/numeric status of the keypad.



Icon	Keypad Status
	Lowercase alpha mode.
	Uppercase alpha mode.
	Numeric mode.

5.5 White Indicators on the Numeric Keys

(Please refer to Pointmobile Keyboard Specification v1.5 document)

The mode is changed as_Numeric / Upper / Lower when you press the white key, you can type each number/ capital letter/small letter in the sequence

Each number key display the characters typed when you press that key in alpha mode.

Note that when typing in alpha mode, you must use the same multi-press method you would use when typing letters on a phone keypad. Each key press types the next letter in the sequence as displayed by the alpha indicator.

5.6 BLUE Key Combinations

Buttons can be programmed to execute different functions using the Program Button program in the Control Panel. The following buttons on the HANDY TERMINAL are programmed for the listed function.

BLUE key modifies the next key pressed to perform specific functions.

Key Combination	Function
BLUE + 1	F1
BLUE + 2	F2
BLUE + 3	F3
BLUE + 4	F4
BLUE + 5	F5
BLUE + 6	F6
BLUE + 7	F7
BLUE + 8	F8
BLUE + 9	F9
BLUE + 0	F10
BLUE + SP	Align the screen (Press ESC to exit)
BLUE + .	Home screen

5.7 Program Buttons

Buttons can be programmed to execute different functions using the Program Button program in the Control Panel. The following buttons on the HANDY TERMINAL are programmed for the listed function.

Key Combination	Function
FSCAN	Do Scan
LSCAN	Do Scan
RSCAN	Do Scan
VOL+	Volume up
VOL-	Volume down
ESC	Esc Key
TAB	Tab Key
BACK SPACE	Bksp Key
ENTER	Return Key
DEL	Del Key
OK	OK
STARTMENU	Start Menu Key
CALI BRATI ON	Touch Calibration
F1	No Action
F2	No Action

F3	No Action
F4	No Action
F5	No Action
F6	No Action
F7	No Action
F8	No Action
F9	No Action
F10	No Action

6 Using the Image Engine

6.1 Overview

The HANDY TERMINAL contains an N560X 2D image engine that instantly reads all popular 1D and 2D bar codes and supports omni-directional aiming and decoding or a N4313 1D laser engine that reads all popular 1D bar codes. The image engine can also capture digital images, such as signatures and pictures.

NOTE: It may not read the barcode due to specular reflection if scanning from directly above. Try again after changing angle.

NOTE: It may not read the barcode, if this handy terminal is too close to or too far from the barcode even if the barcode is within the aiming range. Move the handy terminal toward or away from the barcode slowly and try again. The aiming range is for reference only.

NOTE: It may not read the barcode if the barcode surface is curved. Scan the barcode at the center of the aiming range.

NOTE: It may not read the barcode if the barcode surface is dirty. Try again after cleaning the barcode.

NOTE: It may not read the barcode if the image engine window is dirty. Try again after wiping the window with a cotton swab or similar soft object gently.

NOTE: It may not read the barcode according to the direct sunlight or the brightness of the surrounding. Try again away from the direct sunlight. Try again after adjusting the brightness of the surrounding if indoors.

NOTE: It may not read the barcode if it is blue on white background. Try again after changing angle or adjusting the brightness of the surrounding.

NOTE: It may not read the barcode if it is black on silver background. Try again after changing angle or adjusting the brightness of the surrounding.

NOTE: Bar codes printed on glossy or laminated paper are best read at angles greater than 5° in relation to the Laser Engine. This prevents bright illumination reflections from being returned to the Laser Engine..

NOTE: Performance may be impacted by bar code quality and environmental conditions

NOTE: Misreading may occur, if the bar code isn't positioned correctly. Recommended scanner beam positions are as follows

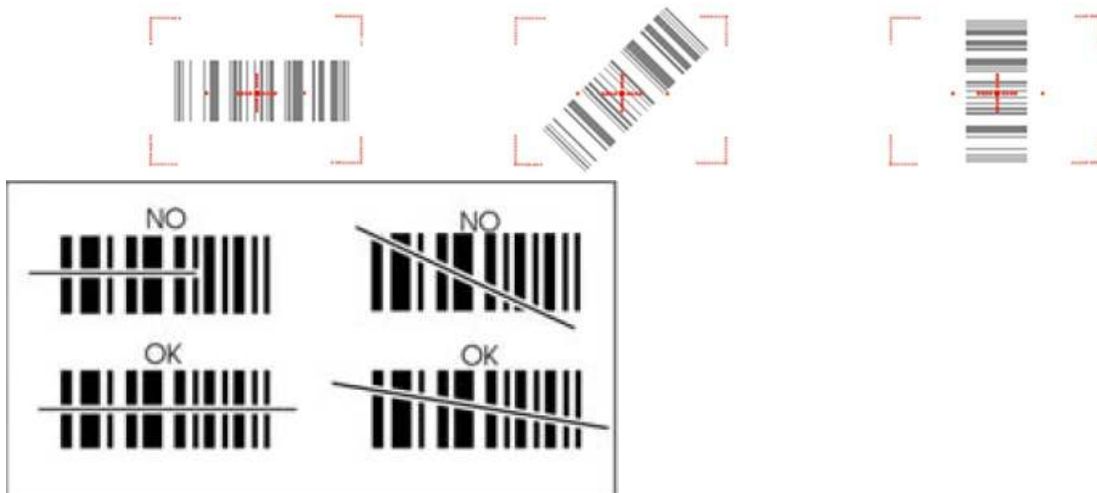

6.2 Available Image Engines

The HANDY TERMINAL is equipped with an N560X.

6.3 Depth of Field

Depth of Field for N560X

Focus	High Density (HD)			Standard Range (SR)			Extended Range (ER)		
	Near Distance (in/cm)	Far Distance (in/cm)	Delta (in/cm)	Near Distance (in/cm)	Far Distance (in/cm)	Delta (in/cm)	Near Distance (in/cm)	Far Distance (in/cm)	Delta (in/cm)
3 mil C39/128	2.2 (5.6)	3.1 (7.9)	.9 (2.3)	-	-	-	-	-	-
5 mil C39/128	1.6 (4.1)	4.5 (11.4)	2.9 (7.4)	3.0 (7.6)	6.1 (15.5)	3.1 (7.9)	5.8 (14.7)	8.8 (22.4)	3.0 (7.6)
7.5 mil C39/128	1.8 (4.6)	5.0 (12.7)	3.2 (8.1)	2.4 (6.1)	8.4 (21.3)	6.0 (12.2)	4.4 (11.2)	13.0 (33.2)	8.6 (21.8)
10 mil C39/128	1.7 (4.3)	5.1 (13.0)	3.4 (8.6)	1.9 (4.8)	12.0 (30.5)	10.1 (25.7)	3.2 (8.1)	16.1 (40.9)	12.9 (32.8)
15 mil C39/128	1.4 (3.6)	7.6 (19.3)	6.2 (15.8)	2.2 (5.6)	17.9 (45.5)	15.7 (40.0)	2.0 (5.1)	19.0 (48.3)	17.0 (43.2)
20 mil C39/128	2.7 (6.9)	8.6 (21.8)	5.9 (15.0)	2.8 (7.1)	17.8 (45.2)	15.0 (38.1)	3.1 (7.9)	22.8 (57.9)	19.7 (50.0)
100% UPC	2.2 (5.6)	6.7 (17.0)	4.5 (11.4)	2.1 (5.3)	15.0 (38.1)	12.9 (32.8)	2.8 (7.1)	19.0 (48.3)	16.2 (41.2)
5 mil PDF417	1.7 (4.3)	4.2 (10.7)	2.5 (6.4)	3.0 (7.6)	4.5 (11.4)	1.5 (3.8)	6.1 (15.5)	7.4 (18.8)	1.3 (3.3)
6.7 mil PDF417	1.7 (4.3)	4.7 (11.9)	3.0 (7.6)	2.5 (6.4)	6.6 (16.8)	4.1 (10.4)	4.7 (11.9)	9.8 (24.9)	5.1 (13.0)
10 mil PDF417	1.8 (4.6)	5.6 (14.2)	3.8 (9.7)	1.7 (4.3)	10.5 (26.7)	8.8 (22.4)	2.4 (6.1)	14.9 (37.8)	12.5 (31.8)
5 mil MicroPDF	1.8 (4.6)	3.2 (8.1)	1.4 (3.6)	-	-	-	-	-	-
5 mil Data Matrix	2.0 (5.1)	3.0 (7.6)	1.0 (2.5)	-	-	-	-	-	-
10 mil Data Matrix/Aztec	1.7 (4.3)	4.7 (11.9)	3.0 (7.6)	2.9 (7.4)	7.3 (18.5)	4.4 (11.2)	5.3 (13.5)	10.0 (25.4)	4.7 (11.9)
20 mil Data Matrix	1.7 (4.3)	7.0 (17.8)	5.3 (13.5)	2.9 (7.4)	14.2 (36.1)	11.3 (28.7)	4.0 (10.2)	16.0 (40.6)	12.0 (30.5)
10 mil QR	1.2 (3.0)	4.7 (11.9)	3.5 (8.9)	2.6 (6.6)	6.9 (17.5)	4.3 (11.0)	4.3 (10.9)	10.4 (26.4)	6.1 (15.5)
20 mil QR	2.2 (5.6)	7.2 (18.3)	5.0 (12.7)	2.0 (5.1)	15.0 (38.1)	13.0 (33)	2.1 (5.3)	17.7 (45.0)	15.6 (39.6)
32 mil Maxicode	2.2 (5.6)	8.3 (21.1)	6.1 (15.5)	2.9 (7.4)	15.3 (38.9)	12.4 (31.5)	4.2 (10.7)	17.7 (45.0)	13.5 (34.3)

NOTE: Test Condition: Room Temperature (Approx. 23°C), 0 Lux.

New picture : N5600-IM Rev E.pdf base.

6.4 Supported Bar Code Symbolologies

Symbology Type	Symbology Name
1D Symbolologies	Codabar Code 11 Code 128 Code 39 Code 93 / 93i EAN-8 EAN-13 Interleaved 2 of 5 Reduced Space Symbology UPC-A UPC-E MSI Trioptic Code Code 32 Pharmaceutical (PARAF) Matrix 2 of 5 Telepen GS1-128 ISBT 128 Straight 2 of 5 (Industrial) UPC-A (Coupon Code) UPC-E1 Straight 2 of 5 (IATA)
2D Symbolologies	Aztec Code Data Matrix MaxiCode MicroPDF417 PDF417 QR Code and Micro QR Code Han Xin
Composite Codes	EAN.UCC Composite Codablock F TCIF Linked Code 39 (TLC39)
OCR	OCR
Postal Codes	Postnet British Post(BPO) Canadian Post Australian Post Japanese Post Planet Code KIX (Netherlands) Post China Post Korea Post 4-CB(4-State Customer Barcode) ID-Tag(UPU 4-State)

6.5 Activating the Engine

When a scanning application is open, press the **Scan** key to activate the image engine.

6.6 Using Demos

Handy Terminal Demos are software utilities loaded on all Handy Terminal terminals that demonstrate the advanced features of the terminal. There are two Demos that feature the image

engine: Image Demo and Scan Demo.

To access these demos, tap **All Apps**  -> **Demos**.

- Select **Scan Demo** to verify decoding, or
- Select **Image Demo** to verify imaging (not available on device using the N4313 laser engine).

6.7 Decoding

The Handy Terminal supports Full-area Imaging decode mode.

Full-area Imaging

With full-area imaging the Handy Terminal supports omni-directional aiming meaning that a positive read can be obtained from many positions. For details, see Omni-Directional Scanning Positions on paragraph 6.10.

6.8 To Decode a Bar Code

1. Tap **All Apps**  -> **Demos** -> **Scan Demo**.
2. Position the Handy Terminal over one of the Sample Bar Codes on paragraph 6.9.
A range of 4–10 inches (10–25 cm) from the bar code is recommended.
3. Project the aiming brackets by pressing and holding the **Scan** key. The Scan LED lights red.
4. Center the aimer crosshair over the bar code. The aiming beam should be oriented in line with the bar code to achieve optimal decoding; Omni-Directional Scanning Positions on paragraph 6.10.
5. When the bar code is successfully decoded, the decode LED lights green and the terminal beeps.

6.9 Sample Bar Codes

You can use the following bar codes to verify decoding:

Code 39



PDF 417

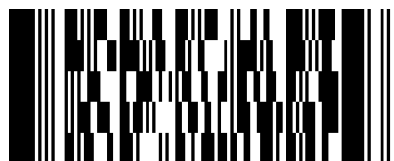

6.10 Omni-Directional Scanning Positions

The high-vis aiming pattern frames the bar code to provide you with the best scanning performance.

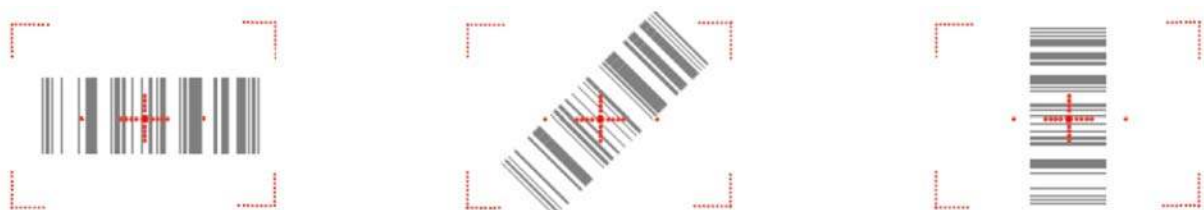

NOTE: To achieve the best read, the aiming beam should be centered horizontally across the bar code.

The aiming pattern is smaller when the terminal is held closer to the code and larger when the terminal is held farther from the code. Symbologies with smaller bars or elements (mil size) should be read closer to the unit whereas larger bars or elements (mil size) should be read farther from the unit.

6.11 Capturing Images

The image-capture process is an intuitive, split-second operation for experienced users. By following basic guidelines, however, new users can easily develop their own technique and, with practice, quickly learn to adapt to different application environments.

Image Preview

When the imaging process is initiated, the touch screen displays a preview of the object. This is a live video image of what the imager is currently viewing and has a slightly degraded appearance compared to the captured image. This is normal; the captured image has a higher resolution.

File Formats

The Handy Terminal supports BMP file format only.

7 Using the Laser Engine

7.1 Overview

The HANDY TERMINAL (N4313 laser version) contains a laser diode that emits a beam toward an oscillating mirror that scans through the code and the reflected light is bounced off of two mirrors back to the collector. The laser version reads all popular 1D bar codes. See Overview on paragraph 6.1 also.

NOTE: Performance may be impacted by bar code quality and environmental conditions.

7.2 Available Laser Engines

The HANDY TERMINAL can be equipped with an N4313 laser engine (depending on the configuration purchased).

7.3 Depth of Field

Depth of Field for **N4313**_[W1]_[V2]

Code Size	Reference Range	
	Near Distance (in/ cm)	Far Distance (in/ cm)

Code 39 4 mil	5in / 12.7cm	5.4in / 13.8cm
Code 39 5 mil	4.1in / 11.7cm	7.2in / 18.4cm
Code 39 7.5 mil	4.1in / 10.4cm	10.7in / 27.4cm
Code 39 10 mil	3.4in / 8.7cm	14.5in / 36.9cm
UPC 13 mil, 100%	1.9in / 4.7cm	16.8in / 42.8cm
Code 39 15 mil	1.9in / 4.7cm	19.9in / 50.4cm
Code 39 20 mil	(*)	25.5in / 64.6cm
Code 39 40 mil	(*)	26.7in / 67.5cm
Code 39 55 mil	(*)	31.8in / 80.8cm

NOTE: Test Condition: Room Temperature (Approx. 20°C), 450 ~ 500 Lux.

NOTE: * = dependent on width of bar code.

7.4 Supported Bar Code Symbologies

Symbology Type	Symbology Name	
1D Symbologies	Codabar	UPC A
	Code 39	UPC E
	Interleaved 2of 5	EAN 13
	Nec 2of5	EAN 8
	Code 93	MSI
	Straight 2of5 Industrial	Plessey
	Straight 2 of 5 IATA	GS1 Databar Omnidirectional
	Matrix 2 of 5	GS1 Databar Limited)
	Code 11	GS1 Databar (Expanded
	Code 128	China Post
	GS1 128	Trioptic
	Telepen	

7.5 Activating the Engine

When a scanning application is open, press the Scan key to activate the laser engine.

7.6 Using Demos

Handy Terminal Demos are software utilities loaded on Handy Terminals that demonstrate the advanced features of the terminal.

7.7 Decoding a Bar Code

1. Tap **All Apps**  > **Demos** > **Scan Demo**.
2. Position the Handy Terminal over one of the Sample Bar Codes on paragraph 7.8.
A range of 4-10 inches (10-25 cm) from the bar code is recommended.

3. Project the aiming beam by pressing and holding the **Scan** key. The Scan LED lights red.
4. Center the aimer beam horizontally over the bar code and highlight all of the vertical bars of the bar code. The aiming pattern is smaller when the terminal is held closer to the code and larger when the terminal is held farther from the code. Symbologies with smaller bars or elements (mil size) should be read closer to the unit whereas larger bars or elements (mil size) should be read farther from the unit.
5. When the bar code is successfully decoded, the decode LED lights green and the terminal beeps.

7.8 Sample Bar Code

You can use the following bar code to verify decoding:



7.9 Scanning Positions

The aiming beam must be aimed across the entire bar code to provide you with the best scanning performance. The aiming pattern is smaller when the terminal is held closer to the code and larger when the terminal is held farther from the code. Symbologies with smaller bars or elements (mil size) should be read closer to the unit whereas larger bars or elements (mil size) should be read farther from the unit.



8 Using ScanWedge



8.1 Overview

ScanWedge sends data from the installed scan engine(N4313 or N560X) to the foreground application as keystrokes or clipboard. The foreground application is the open software application whose window is currently active on the display.

As a result, you can check decoded bar code data with text.

8.2 Enabling ScanWedge

ScanWedge is enabled by default in Handy Terminal



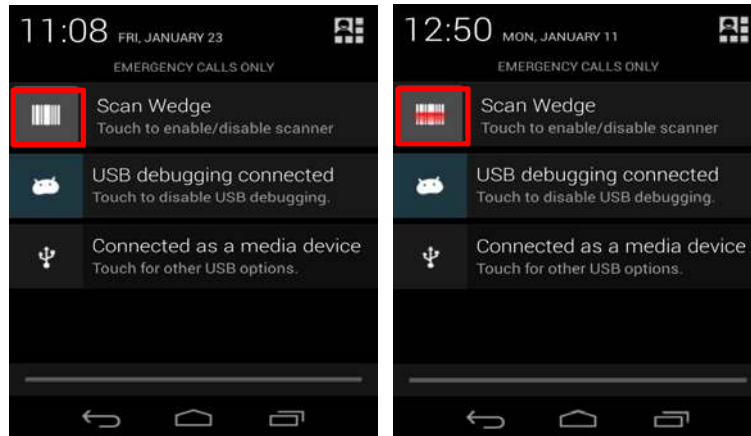

If it is disable, please touch to enable scanner  →  on Notification Panel.



9 Using Control Panel

9.1 Settings

Overview

The Settings allows you to verify and/or alter system parameters to customized your terminal to meet your specific needs. Touch **All Apps**  > **Settings**  or pull down the notification 50panel, and then touch the quick settings icon  next to touch **Settings** icon 

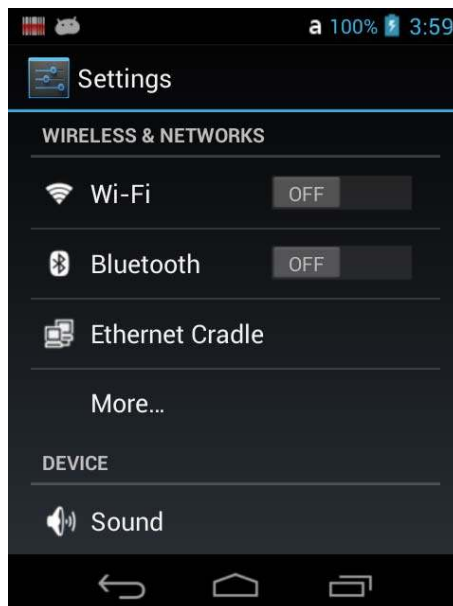

9.1.1 Wireless & Networks Settings

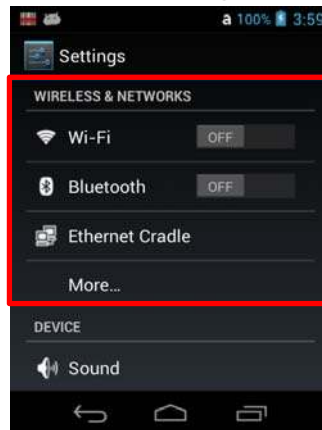

Under the **Wireless & Networks** heading on the **Settings** screen there are options for turning the on board wireless radios in the terminal on or off and for configuring network connections.

See 10.7.1. [Wi-Fi Network Connections](#) on page XX and 11. [Bluetooth Handler](#) on page XX

9.1.1.1 Ethernet Cradle Settings

It is shown the network information to connect to Ethernet Cradle. (IP Address, NetMask, Gateway, DNS1, DNS2, Hardware address)
It can be set up the Automatic IP or Static IP on the Connection.

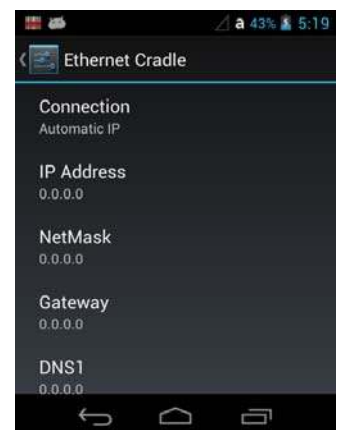



NOTE: The cradle to use Ethernet is marked icon  on the status bar. Also if Ethernet is connected, icon is changed as 

9.1.1.2 More.



Airplane Mode

Turn On Airplane mode to disable all the terminal radios that transmit voice or data.

NOTE: Another way is touch and hold the status bar, and then drag down to open the **Notification Panel**. And touch the  button on the top right of the Notifications panel. Touch  next to **Airplane Mode**.
When Airplane Mode is turned on,  shows on the status bar.

Virtual Private Networks (VPN)

To complete the VPN setup screens, you may need to ask your ISP or network administrator for the proxy server name, server type, port, type of Socks protocol used, and your user name and password if you do not already have the information.

Adding a VPN:



1. Touch **All Apps**  > **Settings** .
2. Under **Wireless & Networks**, touch **More** > **VPN**.

NOTE: VPN connections require you to set a screen lock PIN or password before you can use credential storage. If you have not set either security option, select **OK** on the pop-up notification window, and then set a screen lock PIN or password. Once you complete the process, you are automatically directed back to the VPN screen.

3. Touch **Add VPN network**.
4. Enter the VPN **Name**, and then select the VPN **Type** you want to add. Complete the remaining data fields with the appropriate information for your network. The terminal supports the following protocol types:
 - PPTP
 - L2TP/IPSec PSK
 - L2TP/IPSec RSA
 - IPSec Xauth PSK
 - IPSec Xauth RSA
 - IPSec Hybrid RSA
5. Touch **Save**.

NOTE: To delete a VPN, touch and hold the network name on the **VPN** screen, and then touch **Delete network**. To edit a VPN configuration, touch and hold the network name on the **VPN** screen, and then touch **Edit network**. Touch **Save** to retain your changes.

Connecting to a VPN:

1. Touch **All Apps**  > **Settings** .
2. Under **Wireless & Networks**, touch **More** > **VPN**.
3. Touch the name of the VPN.
4. Enter any security credentials (e.g., password, user name, certificate information or server name) required by the VPN.
5. Touch **Connect**.

NOTE: When a VPN connection is established, a  shows in the status bar.

Disconnecting from a VPN:

1. Drag the status bar down from the top of the touch screen to view the Notification panel.
2. Touch the VPN connection notification to disconnect.

Mobile Networks

- *Data enabled: Enable data access over Mobile*
- *Data roaming: Connect to data services when roaming*
- *APN: it is shown the APN list to use currently. If new APN is added, please put the new APN on the Menu button  of the top of the right*

NOTE: The Access Point Name (APN) is the name for the settings your phone reads to set up a connection to the gateway between your carrier's cellular network and the public Internet.

9.1.2 Device Settings

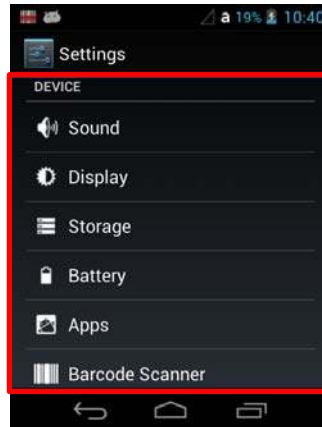

9.1.2.1 Sound Setting

Touch **Sound** from the **Settings** screen then select the configuration setting you want to modify.

- **Volumes** - Set the volume level used for music, videos, games, other media, ring tones, notifications, and alarms.
- **Call Ringtone & Vibrate** - Set the phone ringtone, and turn vibration on or off for incoming calls.
- **System** - Set the Default sound for notifications and on/off the Dial pad touch tones, Touch sounds and Screen lock sound.



9.1.2.2 Display Settings

Touch **All Apps** > **Settings** > **Display** from the screen to set the touch screen **Brightness** level, **Turn on keyboard backlight** on or off, **Wallpaper**, turn **Auto-rotate screen** on or off, adjust the touch **Screen timeout** settings, set the on display **Wakeup Source**, set the on screen **Font size**, and enable or disable some **Power** button functions.

Turn on keyboard backlight

To turn on the keypad backlight, check the checkbox.
The duration of backlight of keypad synchronizes with LCD backlight's.

Auto-rotate screen

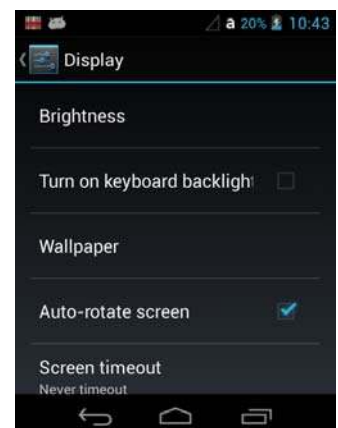

By default, the display automatically adjusts the orientation of the screen between landscape and portrait when the terminal is rotated. Touch the **Auto-rotate screen** checkbox to toggle the option on or off.

Screen timeout

The **Screen timeout** setting enables you to customize backlight functionality for the display. Select how many minutes or seconds you want to elapse before the backlight automatically turns off and the terminal enters **Suspend** mode (see page X-XX).

Wakeup Source

It is shown the change condition from Resume mode to Suspend mode

Font size

To adjust the font size on the system.

9.1.2.3 **Storage Settings**

Touch **Storage** from the **Settings**  screen to view use and space statistics for the internal storage on the terminal and the installed SD card.



9.1.2.4 **Battery Settings**

See 4.18 Managing Battery Power

9.1.2.5 **Apps Settings**

Touch **Apps** from the **Settings**  screen to view, evaluate, and modify how applications installed on the terminal utilize memory and storage resources



Touch the tabs at the top of the **Apps** screen to view lists organized into three categories:

Downloaded

Displays all apps downloaded to the terminal.

To sort the list, press the **Menu** button  at the top of the screen, and then touch **Sort by size** or **Sort by name** or touch the Reset app preferences to reset of App environment setting.

Running

Displays application processes and services running on the terminal and cached background processes. Touch **Show cached processes** or **Show running services** at the top of the screen to switch between the lists.

All Displays

all apps stored on the internal storage of the terminal. To sort the list, press the **Menu** button  at the top of the screen, and then touch **Sort by size** or **Sort by name**. or touch the Reset app preferences to reset of App environment setting.

Displayed at the bottom of each category screen is the memory or storage type, the amount of storage or memory used by the listed applications, and the amount of free space remaining.

Managing Apps

The **App info** screen contains detailed statistics on an app including the amount of storage or cache utilized, default launch settings, and access permissions granted to the app. Statistics useful when troubleshooting slow terminal performance, low memory issues, or an unresponsive application. The **App info** screen also provides access to perform the following actions:

- force stop the app,
- uninstall the app,
- show notifications,
- clear stored data,
- clear cache, or
- clear any Launch by default settings assigned to the app.

To access the **App info** screen, touch the app name on the list displayed under the **Downloaded** tab on the **Settings > Apps** screen

Uninstall Applications

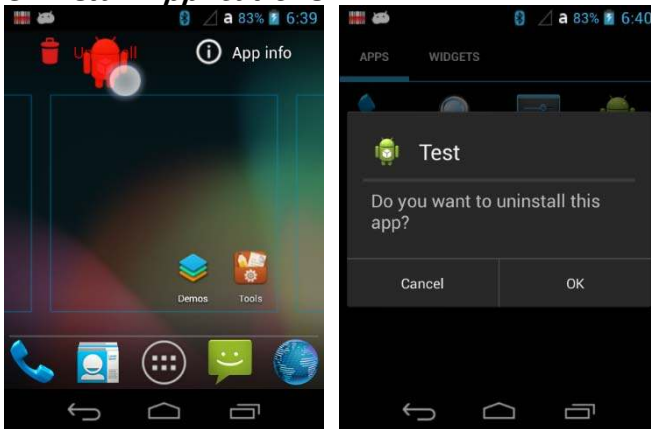

1. On the All Apps ☰ Please drag application on the Uninstall after putting for a second Uninstall
2. Touch the **OK** button to confirm.

Stop Application Processes or Services

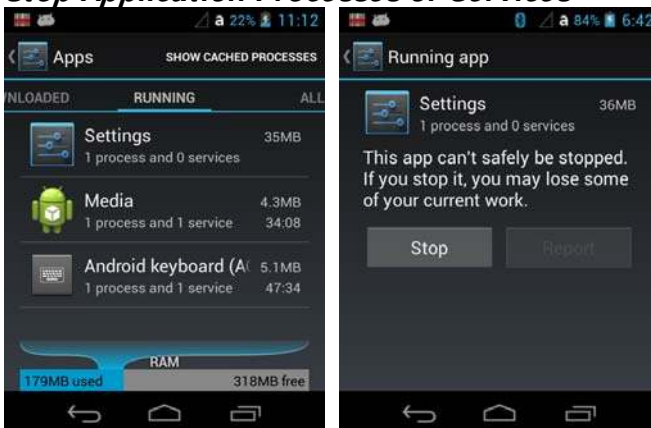

1. Touch **Apps** from the **Settings** screen.
2. Touch the **Running** tab.
3. Touch the cached background process or running service you want to stop.
4. Touch **Stop**.

9.1.2.6 Barcode Scanner Settings

Change the ScanSetting

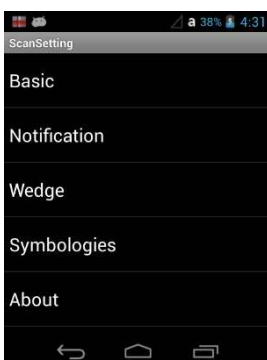

Tab	Section	Option	Description
Basic	Scanning	Trigger timeout (sec)	Specifies the trigger time out in seconds. If a barcode is not decoded within the specified timeout, the default Notifier indicates that decoding is failed
		Enable Auto Scan	Enable Auto Scan with specified interval.
		Auto Scan interval (sec)	Set Auto Scan interval time.
		Enable Continuous Scan	Enable Continuous Scan without any interval.
		Enable Center Window (IT5300SR device only)	Enable Center window. Bar codes are decoded only if they are within the specified windows
		Decode Mode(IT5300SR device only)	Standard: Quick Omni (<i>By default</i>):
		Delay Before Decoding(IT5300SR device only)	Start to decoding after specified milliseconds Values: 0(default), 100, 200, 300, 400, 500, 600, 700, 800, 900, 1000
		Default Enable	Enable/Disable scanner when the device starts
	Wedge mode	Result Type	Select Result Type : Keyboard Event Clipboard(default)
		Terminator	Select the desired barcode end method from the pull down list. Values: None, CRLF, Space
		Power Save Options (N4313 device only)	Power Save TimeOut (sec)
Notification	Beep If enabled – plays audio sound	Enable Beep	Set enable/disable plays audio sound.
		Good read	Set sound to indicate good read.
		Bad read	Set sound to indicate bad read.
	LED	Enable LED	Set enable/disable visual scan indicators.
	Vibrator	Enable Vibrator	Set enable/disable vibrator operation.

	If enabled - Turn on LED for good/bad scan indicator	Good read	Set vibration time after good read.
		Bad read	Set vibration time after bad read.
Wedge	Barcode ID	Transmit Barcode ID	Enable to transmit predefined barcode ID in Detail tab
	Label	Prefix	Enter Prefix to be sent prior to the decoded/received data.
		Suffix	Enter Suffix to be sent after the decoded/received data
Symbologies	Select barcode types you want to read There is "Enable All" and "Disable All" to enable/disable all symbologies		

Tab	Section	Option	Description
About	Specifies Barcode engine type, Firmware revision, Decider revision, API revision		
	Factory Default	Load Factory Default	After modifying the current settings, if you wish to return to the factory defaults, tap the Load Factory Default button.

9.1.3 Personal Settings

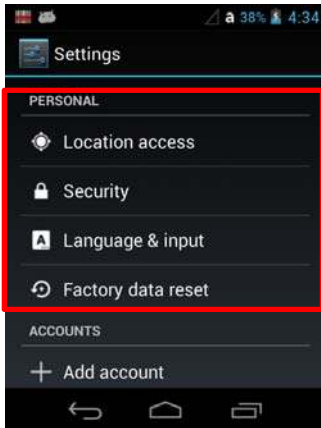

9.1.3.1 Location access Settings

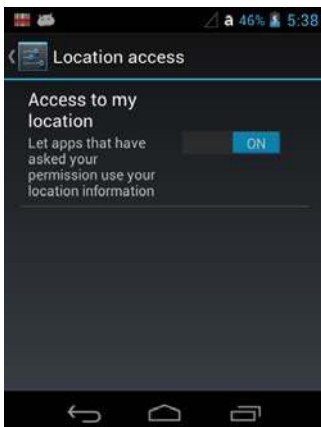

Please on/off to let apps that have asked your permission use your location information.

9.1.3.2 Security Settings

Touch **Security** from the **Settings**  menu to manage terminal security parameters (e.g., authorization for device administration, setup a screen lock, setup a SIM card PIN, enable/disable visible passwords, load security certificates, and setup a password to protect the terminal's credential storage).



Screen Security

The **Screen Lock** settings provide access to additional security features that enable you to prevent an unauthorized person from unlocking the touch screen and accessing the terminal. Select from five security options: **None**, **Slide**, **Pattern**, **PIN** or **Password**.

- To enable a screen lock:
Touch on **Pattern**, **PIN** or **Password** to access additional dialogue screens that step you through setting up or updating the security feature.
- To disable a screen lock:
Touch **Security** from the **Settings** screen. Select **Screen Lock**, and then enter your existing Pattern, PIN, or Password. Touch **Next** and then select **None** to remove the security setting.

Once you have established a screen lock, additional settings may appear under the **Screen Security** heading depending on the type of security you implemented. The additional settings allow you to adjust the time increment for the screen to **Automatically lock** after entering.

Turn On **Power button instantly lock** to lock immediately to Power Button.

The **Owner Info** setting allows you to designate custom text you want displayed on the lock screen. You can also disable owner information from displaying

SIM card lock

Touch **Set up SIM card lock** to establish or modify a SIM card PIN so unauthorized individuals cannot use the terminal as a phone or modify data on the SIM card.

Passwords

Touch the **Make passwords visible** checkbox to toggle between hiding or showing passwords as you type.

Device Administration

The **Device administrators** screen lists all applications that have been given authorization to act as a device administrator, which is often required when you set up accounts that synchronize data between the terminal and an enterprise service. An enterprise service implements security policies on the terminal before allowing a connection (e.g. passwords and certificates). Touch **Device administrators** from the **Security** screen, and then touch the application name if you want to remove authorization for the app to act as a device administrator for the terminal.

Check the **Unknown sources** box to allow the installation of non-market applications. This setting is disabled by default.

Credential Storage

Access options that help you manage your Wi-Fi network and/or Virtual Private Network (VPN) security certificates under the **Credential storage** heading at the bottom of the **Security** settings screen.

NOTE: *Android supports DER-encoded X.509 certificates saved with a .crt or .cer file extension and X.509 certificates saved in PKCS# 12 key store files with a .p12 or .pfx file extension.*

Trusted credentials

Touch **Trusted credentials** from the **Security** screen to view all the security credentials installed on the terminal. Tabs organize the certificates into two categories: **System** and **User**. Touch the certificate name to view additional details about the certificate.

To disable a system certificate or remove a user certificate:

1. Touch the certificate name from the **Trusted credentials System** or **User** list.
2. Scroll to the bottom of the Security certificate details screen.
3. Touch **Disable** or **Remove** depending on the type of certificate you are viewing.

NOTE: *System certificates can be Enabled using the same method at a later date but User certificates are permanently deleted.*



4. Select **OK**

Install from SD Card

To install encrypted certificate from the SD card installed in the terminal:

1. Copy the certificate from the host device (computer) to the root directory of the SD card.

NOTE: *Ensure your certificates are saved with the correct file extension. Android supports DER-encoded X.509 certificates saved with a .crt or .cer file extension and X.509 certificates saved in PKCS# 12 key store files with a .p12 or .pfx file extension.*

2. Touch **All Apps**  > **Settings**  > **Security** > **Credential Storage**.
3. Touch **Install from SD card**.
4. Touch the file name of the certificate to install and enter a password if required.
5. Touch **OK**.

6. Enter the name of the certificate, and then touch **OK**.



NOTE: Once an encrypted certificate is installed on the terminal, it is automatically deleted from the SD card.

9.1.3.3 Language & input Settings



Touch **Language & input** from the **Settings** screen to access options to modify the default language for the display, change the automatic spelling correction settings, manage your personal dictionary, configure keyboard & input methods for text entry, manage speech settings for voice searches and text- to-speech output and set the mouse/trackpad pointer speed.

Language



Touch **All Apps**  > **Settings**  > **Language & input** > **Language**, and then select the language you want displayed on the touch screen.

Spelling checker

Touch **All Apps**  > **Settings**  > **Language & input** > **Spelling correction** to turn the feature on or off.

Touch  to change the language settings when the feature is turned on.

Personal Dictionary

Touch **All Apps**  > **Settings**  > **Language & input** > **Personal Dictionary** to add, edit, or delete words from your personal dictionary.

Keyboard & Input Methods

The enhanced Point Mobile virtual keyboard appears when you open an application or select a field that requires text or numerical input. The content of the keyboard may vary depending on the selected default, the application in use, and the input field requirements.

To modify the default method for entering text:

1. Touch **All Apps**  > **Settings**  > **Language & input** > **Default**.
2. Select an input method **Android Keyboard** or **Enhanced Keyboard**.



NOTE: *PM60 terminals are shipped from the factory configured to use the **Android Keyboard(AOSP)** as the default input method.*

Touch  next to the keyboard name to adjust settings specific for the keyboard type (e.g., Keyboard Skin, Vibrate on Key Press, Sound on Key Press, Show Key Preview, Show Settings Key, and Input Language Preference).

Speech



To configure **Voice Search** settings, touch **All Apps**  > **Settings**  > **Language & input** > **Voice Search**. The settings screen provides access for you to:

- Set the default Language used for voice searches.
- Set SafeSearch sensitivity levels to filter explicit images when using Google Voice Search.
- Enable/Disable offensive language blocks for voice results.

To configure **Text-to-speech (TTS)** settings, touch **All Apps**  > **Settings**  > **Language & input** > **Text-to-speech output**. The settings screen provides access for you to:

- Select and configure the preferred engine used for speech synthesis when you want to hear text read aloud.
- Adjust the Speech rate of the synthesized voice.
- Listen to an example of speech synthesis based on the current settings.

Mouse/ Trackpad

Touch **All Apps**  > **Settings**  > **Language & input** > **Pointer Speed** to adjust the sensitivity and speed of the touch screen response to your finger swipe.

9.1.3.4 Factory data reset

After remove all data in the internal storage, it is initialized as first status

9.1.4.4 Accounts Settings

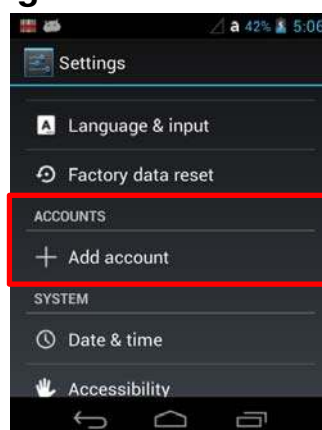



Touch **Accounts** from the **Settings** screen to add, remove, and manage exchange accounts (e.g., e-mail) and allow apps to automatically schedule and sync data.

To add an account:

1. Touch **All Apps**  > **Settings**  > **Accounts**

2. Touch **Add account**.
3. Touch the type of account to add.
4. Follow the on-screen instructions to enter the required information for the account type selected. You may need to provide a user name and password, select security settings, and configure data sync preferences during the setup.
5. The account appears on the Accounts list when setup is complete. Depending on the settings you selected during the account configuration, your terminal may automatically start to sync account data (e.g., email, contacts, music and calendar).

To remove an account:

1. Touch **All Apps**  > **Settings**  > **Accounts > Your Account**
2. Touch the account to delete.
3. Press the **Menu** button  at the top of the screen and then select **Remove account**.
4. Touch **Remove account** to confirm deletion.

9.1.4 System Settings

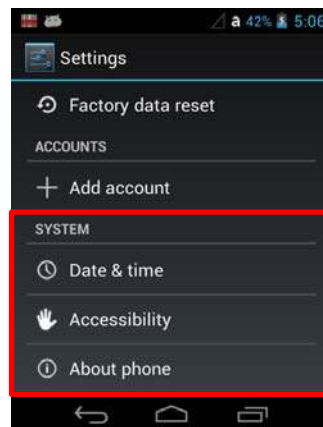

9.1.4.1 Date & Time Settings

Touch **Date & time** from the **Settings**  screen to access options to configure the date, time, time zone, time format, and date format displayed on the terminal. You can set the terminal to synchronize the date and time using a network connection by checking the **Automatic date & time** box or you can manually enter the values by touching **Set date**, **Set Time**, or **Select Time zone**.

NOTE: If the Automatic option is checked, the **Set date**, **Select Time zone**, and **Set time** menu options are grayed out.

To modify how the time is displayed on the screen, check the **Use 24-hour format** box to switch from a 12-hour cycle to a 24-hour cycle. In a 24-hour time cycle, 1:00 pm displays as 13:00 pm.

To change the date format displayed on the screen, touch **Select date format**, and then select a format from the list.

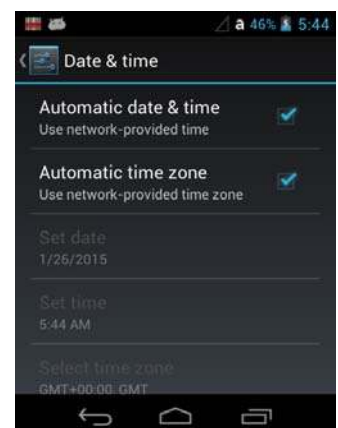

9.1.4.2 Accessibility Settings

Touch **Accessibility** from the **Settings**  screen to configure features that make using the terminal easier for people with certain physical disabilities.

System

Under the **System** heading on the **Accessibility** screen, additional options are available to enable or disable Large Text, speak passwords, or ending calls using the **Power** button . You can also set Touch & hold delay settings and permissions for installing web scripts.

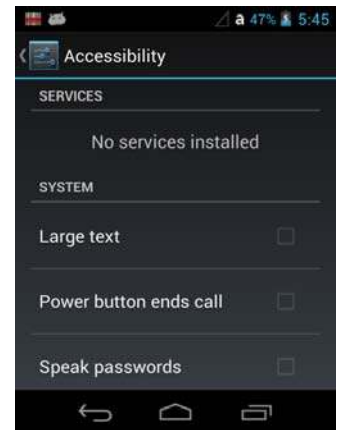

9.1.4.3 Developer options

Touch **Developer options** from the **Settings**  screen to access advanced settings used by Android application developers. For information on these settings, Android APIs, and development tools, refer to the Android developer web site at <http://developer.android.com>.

9.1.4.4 About Phone

The **About Phone** screen displays specific information about the terminal including: Model number, Android version, Baseband version, Kernel version, and Build number.

Touch **System Updates** to view the last time the Android operating system was updated or to manually initiate an Android update.

Touch **Legal information** to view important information on Open source software licenses.

NOTE: *The content of the About phone is based on the terminal model type*

9.2 Program Buttons Settings

To use the **Program Buttons**, tap **All Apps**  > **Tools**  > **Program Buttons**.

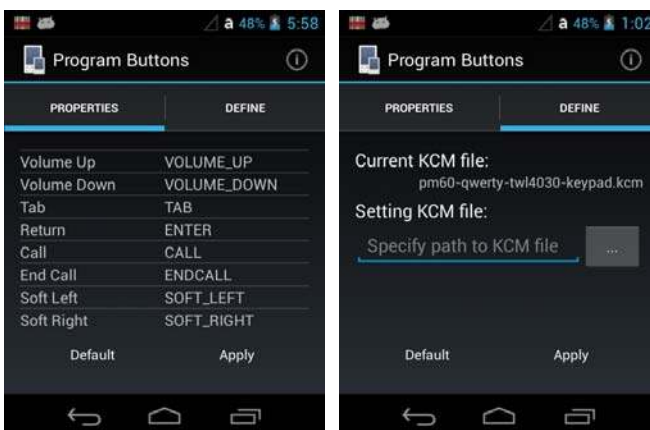

9.2.1 Properties

To change the setting of the button:

1. Select the button you want to change.

2. Chose its type:
Default – button will be assigned default function.
Application – click on **Open** button and select application to bind with this key.
3. To exit, press **OK** button.
4. To apply, press **Apply** button.



9.2.2 Define

Apply and Set the key which is already defined.

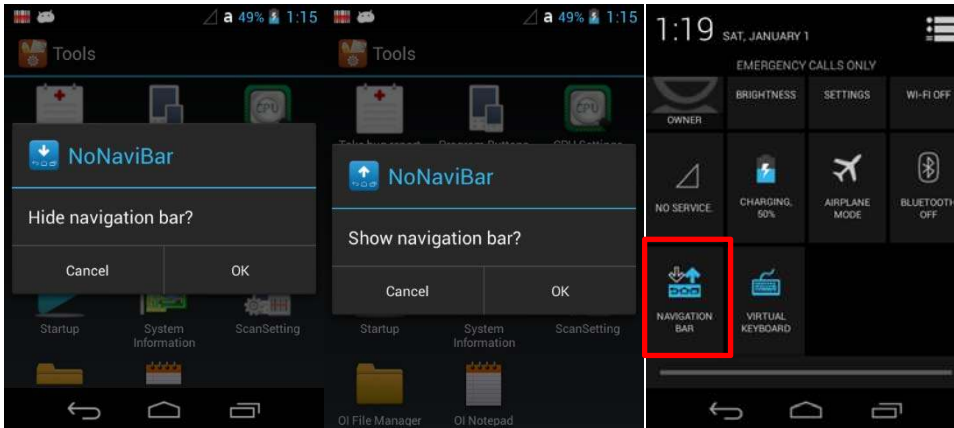
9.3 NoNaviBar



Hide / Show Navigation Bar

Tap All Apps  > Tools  > NoNaviBar or Quick Settings Panel or you can use the Quick setting Panel

9.4 NoSIP

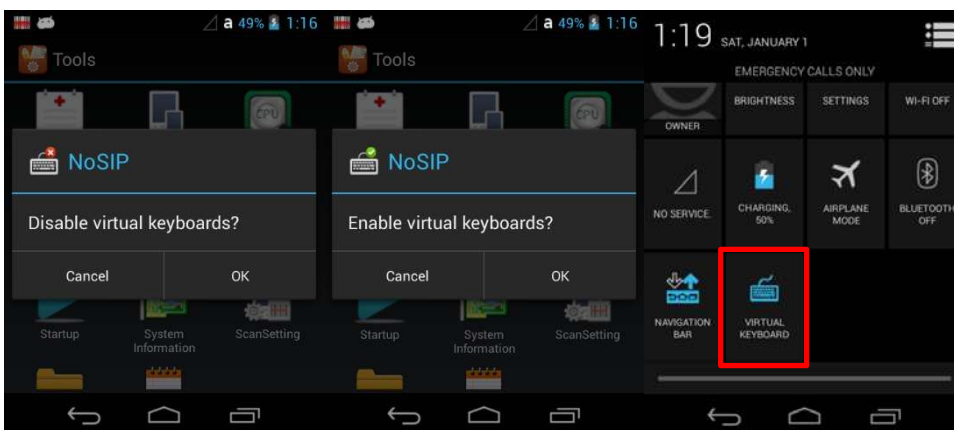

Disable / Enable virtual Keyboard

Tap All Apps  > Tools  > NoSIP or you can use the Quick setting Panel

10 Communication

10.1 Communication Options

Handy Terminal offers several communication options including MTP(or PTP) and wireless radios.

USB Connector

The MicroUSB connector on bottom side supports USB 2.0 High speed

Wireless Radios (Wireless Communication)

HANDY TERMINALS can be equipped with an 802.11b/g/n Bluetooth radio and WWAN.

For more information, see Wireless Radios on paragraph 10.6.

10.2 Communication Type

The HANDY TERMINAL supports the following type of communication via USB through its I/O connector on the bottom panel:

USB The USB cable and hardware peripherals allow the Handy Terminal to communicate with a workstation through a USB port or to a network through a USB hub. The Handy Terminal supports high -speed USB communication (USB 2.0); maximum data transfer rate is 480 Mbps. The Handy Terminal defaults to USB communication out of the box.

10.3 Hardware Requirements for Setup

- AC Adaptor (if needed)
- USB Cable (for USB communication)
- Windows XP, Windows Vista, Windows 7 computer.

10.4 Connect to a Windows computer via USB

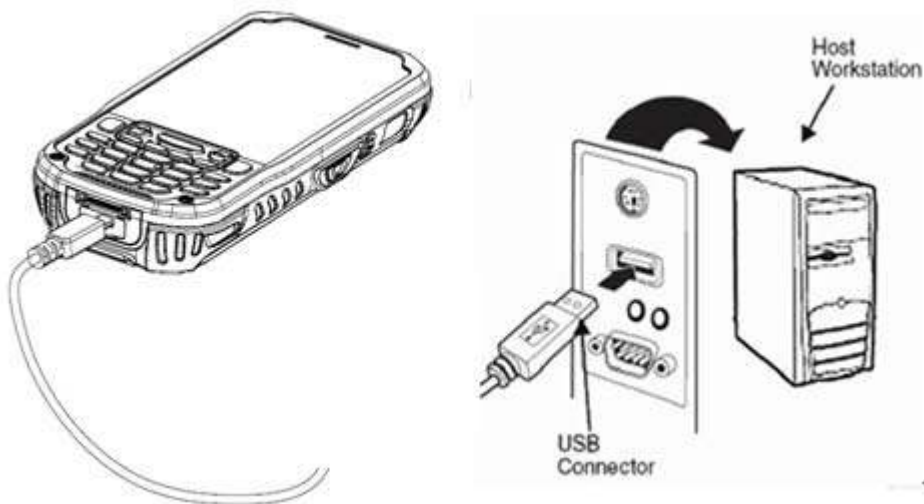

You can use a USB cable to connect your phone to a Windows computer and transfer music, pictures, and other files in both directions. This connection uses the MTP protocol.

If you are using USB tethering, you must turn that off before you can use USB to transfer files between your tablet and computer.

When you connect your phone to the USB port on your computer, its USB storage is mounted as a drive and appears on your computer screen. You can now copy files back and forth as you would using any other external device.

When you're finished, simply disconnect the phone by unplugging the USB cable

USB Connection Settings

1. Tap **All Apps**  > **Settings**  > **Storage** > **Menu**  > **USB Computer connection**
2. Select **Media device(MTP)** or **Camera(PTP)**

NOTE: it can be set up on "Notification panel > Connected as a media device"

10.5 Exploring the Terminal from the Workstation

After PDA is connected to computer, Portable device is shown up on my computer

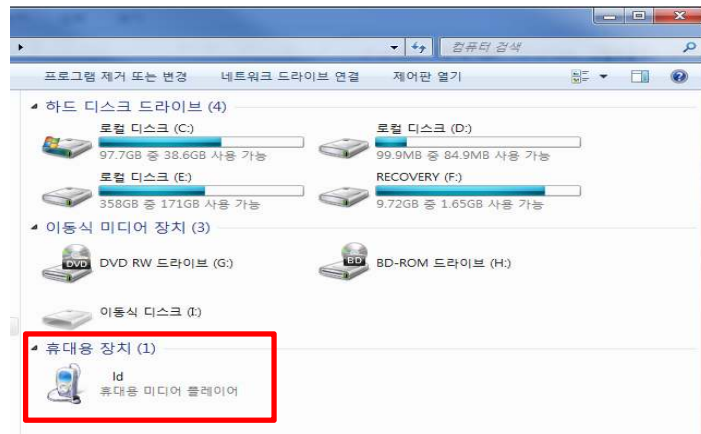

After open the Media Player, internal storage and (SD card)External Storage is shown up.

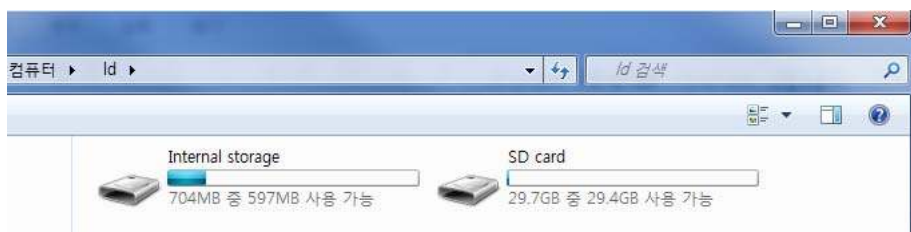

The Handy Terminal is now treated as a mass storage device, and transferring files is as simple as dragging and dropping or copying and pasting as you would for moving files between folders on your

10.6 Wireless Radios

There are four radio options: 802.11b/g/n Bluetooth, Phone and GPS.

1. **802.11 b/ g/ n** (WLAN configuration): Integrated Wi-Fi (802.11b/g/n Radio), up to 72.2Mbps
2. **Bluetooth** (WPAN configuration): Integrated Bluetooth v2.1+ EDR
3. **Phone** (WWAN configuration): 3G WWAN HSPA+ Module
4. **GPS:** Module inherent to HSPA+ Module

NOTE: PM60 does not provide all Bluetooth profiles.

10.7 Connecting the Terminal to a Wireless Network

You connect the terminal to a wireless network through the on-board radio (802.11b/g/n Bluetooth

and/or Phone).

Each radio has its own configuration program and requires specific information about the wireless network to connect. Successful connection depends on your network infrastructure about which you will need specific information from your network administrator.

NOTE: 802.11 b/g/n radio module is off by default, in order to avoid wasting energy, you can switch it off using the Wireless Communications applet

NOTE: Suspending the terminal powers off the 802.11 b/g/n radio and drops the radio connection. When the terminal resumes, depending on the radio power mode and security protocol selected, it may take up to 30 seconds for the 802.11 b/g/n radio drivers to re-associate the radio to the network.



NOTE: Area coverage and radio performance may vary, due to environmental conditions, access points types or interference caused by other devices (microwave ovens, radio transmitters, etc.). If necessary, please turn off the WLAN or Bluetooth.

NOTE: Radio performance may vary if using WLAN, Bluetooths and Phone and phone imultaneously. If necessary, please turn off either WLAN or Bluetooth and/or Phone..

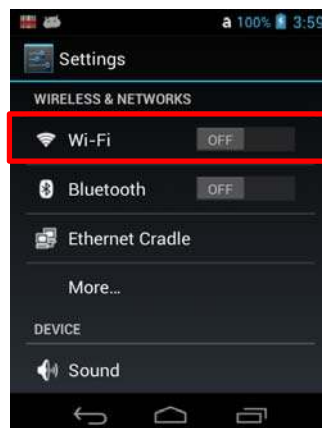
10.7.1 Wi-Fi Network Connections



Turning Wi-Fi Networking On or Off

1. Touch **All Apps**  > **Settings** 
2. Touch the **Wi-Fi** OFF/ON toggle box to turn the radio  or .

Connecting to a Wi-Fi Network

1. Touch **All Apps**  > **Settings**  > **Wi-Fi**.
2. Verify the Wi-Fi is turned .
3. The terminal searches for available Wi-Fi access points within range of the device. If the terminal previously connected to a Wi-Fi network, it automatically reconnects to the same network.

NOTE: To remove a Wi-Fi network the terminal previously connected to, touch the network name, and then touch **Forget**, to delete the stored network information.



4. Touch the network name you want to connect to from the available network list.
5. If the network is secured, a dialog box appears requesting information relevant to the network security protocol (e.g., password, key, or certificate). Enter the required information.
6. Touch **Connect**.

Receiving Network Notifications

If Wi-Fi networking is turned On, you can set the terminal to notify you when an open network is available.

1. Touch **All Apps**  > **Settings**  > **Wi-Fi**.
2. Press the **Menu** button  on the bottom right, and then touch **Advanced**.
3. Touch the check box to toggle **Network notification** On (checked) or Off.

Adding a Wi-Fi Network

1. Touch **All Apps**  > **Settings**  > **Wi-Fi**.
2. Verify the **Wi-Fi** is turned  ON.
3. Touch **Add Network** located at the bottom of the available Wi-Fi network list.
4. Enter the **Network SSID** (Wi-Fi network name).
5. For secure Wi-Fi network connections, touch **None** under **Security**, and then select the type of security protocol required from the pop-up menu (e.g., **WEP**, **WPA/ WPA2 PSK** or **802.1xEAP**).
6. Enter any additional security information required by the type of security protocol selected.
7. Touch **Save**.



10.7.2 *Advanced Wi-Fi Settings and Network Utilities*

Advanced Wi-Fi Menu

The Advanced Wi-Fi menu provides access to set network notifications, modify Wi-Fi radio activity during Suspend mode, idle timeout settings, or view the terminal MAC address and IP address.

- *Network notification*
Turn on or off available Wi-Fi network notification.
- *Keep Wi-Fi on during sleep*
Set how the Wi-Fi radio reacts when the terminal enters sleep (Suspend) mode (i.e., Always, Only when plugged in, or Never).
- *Wi-Fi idle timeout.*
Adjust how long the Wi-Fi may be idle before the radio is automatically turned off (i.e., 1 minute, 3 minutes, 15 minutes (default), 30 minutes, 1 hour, or 3 hours)
- *MAC address*
- *IP address*

To access the advanced Wi-Fi menu settings:

1. Touch **All Apps**  > **Settings** .
2. Under **Wireless & Networks**, touch **Wi-Fi**.
3. Press the **Menu** button  on the bottom right.
4. Select **Advanced**.

10.8 *WLAN (802.11 b/ g/ n Radio)*

HANDY TERMINAL has a 2.4 GHz **802.11 b/ g/ n** WLAN (Wireless Local Area Network) radio that uses Direct Sequence Spread Spectrum (DSSS) technology. The radio is interoperable with other

802.11b/g/n, Wi-Fi compliant products including access points (APs), workstations via PC card adapters, and other wireless portable devices.

By default, the 802.11b/g/n radio is powered-off (i.e., disabled) “out of the box” To power it on (i.e., enable), press the vertical arrow (bottom right corner of screen) and select **Turn Wireless LAN On**. The enable/disable state of the radio will survive subsequent soft and hard resets. The next step is to configure the connection parameters of the radio to connect to a wireless network.

Configuring the WLAN Radio





The WLAN radio is configured in the Pointmobile WLAN Client, which you access by the program icon in the status bar.

11 Bluetooth Handler

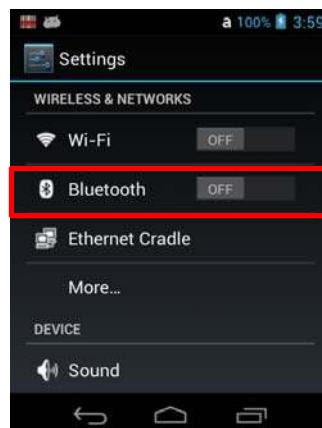
Bluetooth wireless technology is a short-range communications technology to connect portable and/or fixed devices while maintaining high levels of security.

11.1 Enabling the Bluetooth Radio



1. Tap **All Apps**  > **Settings** 
2. Tap the **Bluetooth** OFF/ON toggle box to turn the radio  or .

The Bluetooth icon  appears in the status bar.

NOTE: In order to avoid wasting energy, the Bluetooth, module is off by default. If you need to have Bluetooth working, the module must be powered on using the Wireless Communications applet.

NOTE: Suspending the terminal powers off the Bluetooth radio and drops the Bluetooth connection. When the terminal resumes, it takes approximately 10 seconds for the Bluetooth radio driver to re-initialize the radio.

NOTE: Area coverage and Bluetooth radio performance may vary, due to environmental conditions or interference caused by other devices (microwave ovens, radio transmitters, etc.).

11.2 Connecting to Other Devices

Before connecting to another device, make sure that the Bluetooth connection on the other device is enabled.

1. Tap **All Apps**  > **Settings**  > **Bluetooth**

The Bluetooth Handler appears on the screen.

2. Tap **Search for Devices** button at the bottom.

The available services of all devices / profiles in range display in the Bluetooth Handler.

11.3 *Pairing Bluetooth Devices*

Connecting Bluetooth devices usually requires that they be paired; the same passkey must be entered for each device. If you want to connect the HANDY TERMINAL to a device without any input method (e.g., printers, headsets), refer to the user documentation that accompanied the device for pairing information.

1. Tap on the desired device / profile in the Bluetooth Handler.
2. Tap the **Pair** Button at the bottom

Once asked if you need to authenticate the device,

3. Enter 4 random digits and tap the Next button. (If there is no Password, it is no needed)
4. Enter the same digits on the other device when prompted.
5. After pairing, tap on the icon  of the selected device / profile and select Active.

11.4 *Setting Up a Bluetooth Printer*

1. Make sure that the Bluetooth printer is on and activated.
2. If not done so already, turn Bluetooth On (by selecting the vertical arrow on the Status Bar).
3. Tap **Search for Devices**, which runs a Bluetooth Inquiry, then SDP Query.
4. If you see your Bluetooth printer device displayed. You can press the Refresh button to search again.

12 Single Slot cradle/ Single Ethernet cradle Device

NOTE: *The cradle is option accessory and needed to purchase separately with incidental expenses in the aftermarket*

12.1 *Overview*

NOTE: *The information in this chapter applies to both the Single Slot cradle and Single Ethernet cradle devices unless otherwise indicated.*

As the hub of your HANDY TERMINAL system, the Single Slot cradle charging and communication cradle supports full-speed USB 2.0 with a workstation. The Single Ethernet cradle is identical to the Single Slot cradle except it supports Ethernet communication as well as full-speed USB 2.0

12.2 *Battery Charging*

The base should complete a full charge of the battery pack in 5 hours for the standard capacity 4000mAh: 60-BTSC pack on the handy terminal. .

In addition to charging, the base powers the terminal's intelligent battery charging system, which protects the battery from being damaged by overcharging. The terminal senses when a battery pack is fully charged and automatically turns off the charger. If the battery voltage drops below the charge threshold, the charger turns on again to maintain the battery at full capacity. As a result, Handy Terminals may be stored in the base indefinitely without damage to the terminals, battery packs, or peripherals. For prolonged storage, see Storage Guidelines on paragraph 4.18.

12.3 **Power Supply**

The power cable that ships with each terminal also powers the base.



WARNING: We recommend use of Pointmobile peripherals, power cables, and power adapters. Use of any non-Pointmobile peripherals, cables, or power adapters may cause damage not covered by the warranty. We recommend use of Pointmobile Li-Ion battery packs. Use of any non-Pointmobile battery may damage not covered by warranty.

AVERTISSEMENT: Nous recommandons l'utilisation des périphériques, câbles d'alimentation et les adaptateurs électriques fournis par Pointmobile. L'utilisation de tout autre périphérique, peut causer des dommages non couverts par la garantie.

Nous recommandons l'utilisation de batteries Li-Ion approuvées par Pointmobile. L'utilisation de toute autre batterie peut causer des dommages non couverts par la garantie



WARNING: DO NOT attempt to charge damp/wet handy terminals or batteries. All components must be dry before connecting to an external power source.

AVERTISSEMENT: Nous recommandons l'utilisation des périphériques, câbles d'alimentation et les adaptateurs électriques fournis par Pointmobile. L'utilisation de tout autre périphérique, peut causer des dommages non couverts par la garantie.

Nous recommandons l'utilisation de batteries Li-Ion approuvées par Pointmobile. L'utilisation de toute autre batterie peut causer des dommages non couverts par la garantie

12.4 **Front Panel**

Terminal Well

Place the Handy Terminal in the terminal well to communicate with a host device, power the terminal, and charge the terminal's battery. Make sure that the device is securely seated.

Rubber Feet

The bottom panel has four rubber feet to stabilize the unit on a flat surface. You can set the base on a dry, stable surface, such as a desktop or workbench near an electrical outlet.

Charging LED

If the LED is red, the unit is charging; if it is green, the charge is complete.

12.5 **Back Panel**

Single Slot Cradle

Single Ethernet Cradle

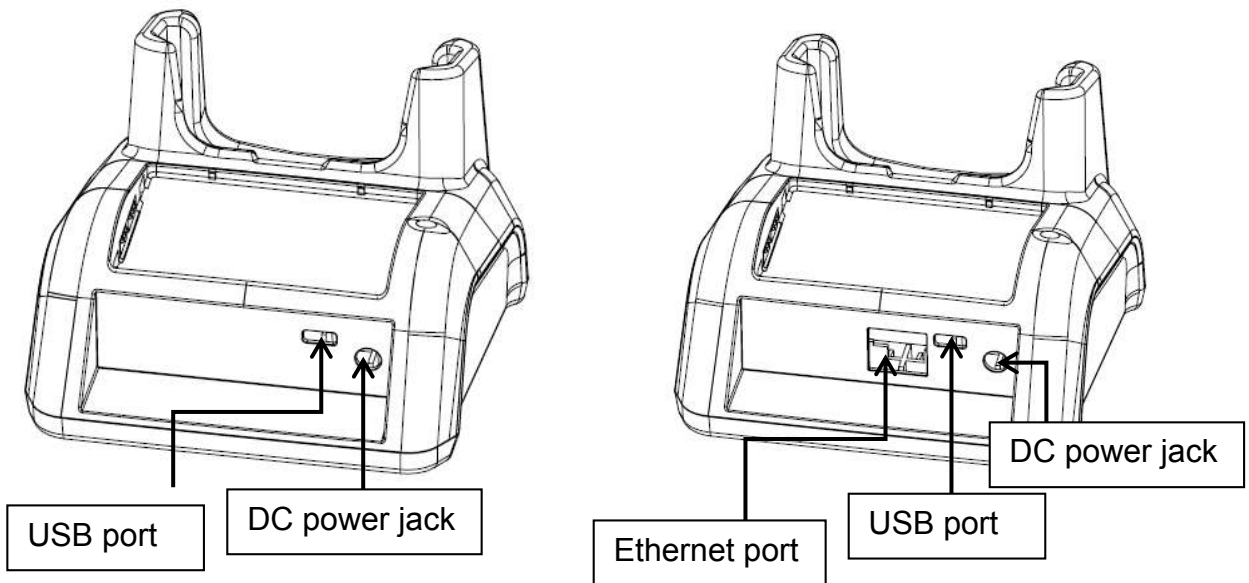

DC Power Jack

Connect the power cable to this power jack; see powering the Single Slot Cradle Device on paragraph 12.6.

USB Port

The USB port is full-speed (v2.0). Using the USB cable, you can connect the base to a USB-compliant device to facilitate USB communication to and from the terminal, see USB Communication on paragraph 10.4.

Ethernet Port (Single Ethernet cradle only)

Using an Ethernet cable, you can connect the Single Ethernet cradle to an Ethernet-compliant device to facilitate Ethernet communication to and from the terminal. This equipment is for indoor use only. The communication wiring is limited to the inside of a building.

12.6 ***Powering the Single Slot Cradle or Single Ethernet Cradle Device***

The terminal requires DC 5V input for communication and battery charging; the power adapter on the power cable converts the voltage from the power source to DC 5V. Only power adapter cables from Pointmobile convert the voltage appropriately.

The same power cable that ships with each terminal can be used to power the base. This cable contains a plug adapter for each geography (US, UK, EU, etc.).

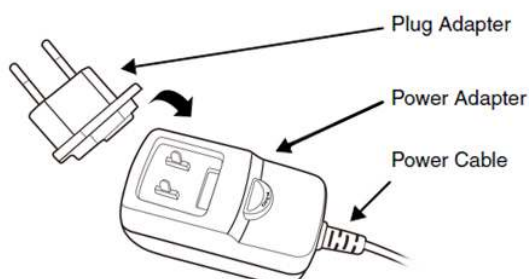

1. Attach the appropriate plug adapter to the power adapter.
2. Plug the power cable into the power source.
3. Plug the connector into the DC power jack on the back panel. The base is now powered.

When a terminal is properly seated, the base powers the terminal, charges the terminal's main battery pack, and launches MTP (see USB Communication on paragraph 10.4).

Pointmobile recommends that you leave the base connected to its power source at all times, so that it is always ready to use.

12.7 ***Charging the Battery***

The base powers the terminal and fully charges the battery pack in 5 hours depending on the battery.

As battery packs charge, the charging circuitry follows the two-step charging process (CC-CV) that is recommended for Li-Ion batteries.

The process monitors changes in temperature, current, and voltage.

The battery can be inserted in the battery charging well in back of the terminal connection. Angle the battery as shown. Once the connectors engage, the LED lights. If the LED is red, the unit is charging; if it is green, the charge is complete



WARNING: Do not short-circuit between each contact of the cradle. It may cause fire.

AVERTISSEMENT: Provoquer un court-circuit entre les contacts de la station d'accueil, pourrait provoquer un incendie.

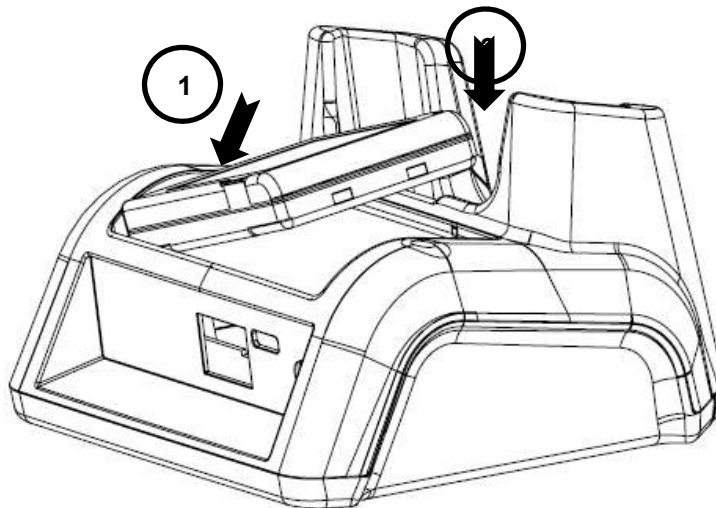

12.8 ***Technical Specifications for Cradle***

Model	60-SSC (Single Slot Cradle) 60-SEC (Single Ethernet Cradle)
Structural	
Dimensions	135.5mm(L) x 116mm(W) x 81mm(H)
Weight	Single Slot cradle - 315g Single Ethernet cradle - 320g

Material	Polycarbonate
Color	Black
Environmental	
Operating Temperature	-20° to 55°C
Storage Temperature	-25° to +70°C
Charging Temperature	0~ 45°C (± 3°C)
Electrical Static Discharge	Air: ± 15Kv Direct: ± 8 kV
Humidity	95% humidity (non-condensing)
Power Supply	
Input (Universal) (from the power source)	AC 100–240 Vac. 50/60Hz 0.9A Included with Cradle
Output (to the cradle)	DC 5V , 4A
Charging	
Standard Charge	Main battery: Standard Capacity:4000mAh (60-BTSC) – Approx. 5hours
Status LED	Green: charged Red: charging
Communication	
Interface	MicroUSB connector supports data transmission of up to 480Mbps OR Ethernet 10/100BASE-T(support only PM60-SEC)
Agency Approvals	
Power Supply	UL listed TUV licensed Power Supply compliant to FCC part 15, Class B
Charging	CE Marking (EMC) CISPR Pub 22
Fire Retardant	UL 94- HB

13 4-Slot Battery Charger

NOTE: The 4-Slot Battery Charger is option accessory and needed to purchase separately with incidental expenses in the aftermarket

13.1 Overview

The 4-Slot Battery Charger device is a four-slot charging station that should charge up to four Li-ion battery Packs (**standard capacity 4000mAh : 60-BTSC**) in five hours. For more details about

charging, see Battery Charging on page 13-2.

13.2 Power Supply

The power cable that ships with each charger



WARNING: We recommend use of Pointmobile peripherals, power cables, and power adapters. Use of any non-Pointmobile peripherals, cables, or power adapters may cause damage not covered by the warranty. We recommend use of Pointmobile Li-Ion battery packs. Use of any non-Pointmobile battery may damage not covered by warranty.

AVERTISSEMENT: Nous recommandons l'utilisation des périphériques, câbles d'alimentation et les adaptateurs électriques fournis par Pointmobile. L'utilisation de tout autre périphérique, peut causer des dommages non couverts par la garantie.

Nous recommandons l'utilisation de batteries Li-Ion approuvées par Pointmobile. L'utilisation de toute autre batterie peut causer des dommages non couverts par la garantie



WARNING: DO NOT attempt to charge damp/wet handy terminals or batteries. All components must be dry before connecting to an external power source.

AVERTISSEMENT: NE PAS tenter de recharger des terminaux ou des batteries encore humides ou mouillés. Tous les pièces et parties doivent être sèches avant la connexion à une source d'alimentation externe

13.3 Front Panel

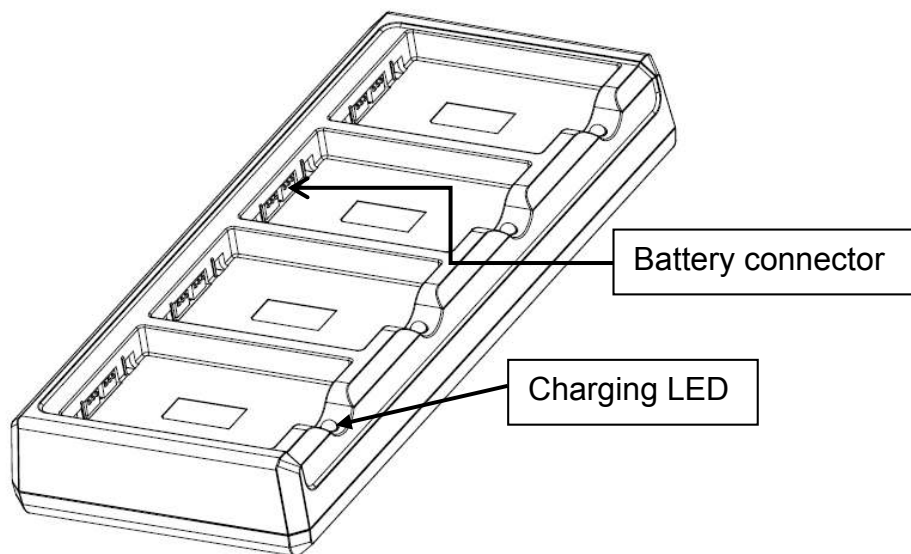

Charging Slots

The charger contains four charging slots. Each slot holds one battery. When a battery is placed in a slot, it immediately begins charging and its Status LED lights.

Rubber Feet

The bottom panel has six rubber feet to stabilize the unit on a flat surface. You can set the charger on a dry, stable surface, such as a desktop or workbench near an electrical outlet.

Charging LED

If the LED is red, the unit is charging; if it is green, the charge is complete.

13.4 **Back Panel**

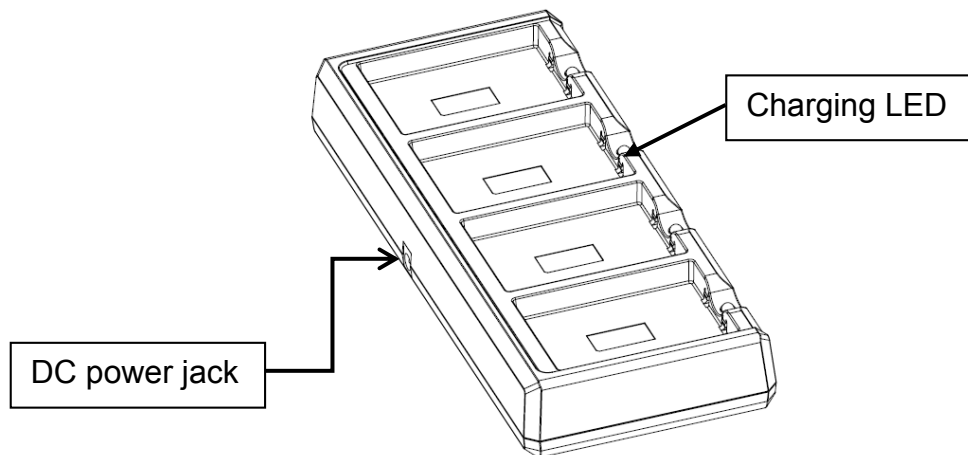

DC Power Jack

Connect the power cable to this power jack; see powering the Single Slot Cradle Device on paragraph 12.6.

13.5 **Charging the Battery**

The base powers the terminal and fully charges the battery pack in 5 hours depending on the battery.

As battery packs charge, the charging circuitry follows the two-step charging process (CC-CV) that is recommended for Li-Ion batteries.

The process monitors changes in temperature, current, and voltage.

The battery can be inserted in the battery charging well in back of the terminal connection. Angle the battery as shown. Once the connectors engage, the LED lights. If the LED is red, the unit is charging; if it is green, the charge is complete

Temperature has a significant effect on charging. For best results, battery packs should be at room temperature before inserting in the charger.

⚠ *When the battery temperature exceeds 45°C, the charger may exceed the stated five-hour charge time. The charger stops charging if the battery temperature is greater than 45°C, but will begin charging again when the battery temperature is less than 45°C.*



WARNING: Do not short-circuit between each contact of the cradle. It may cause fire.

AVERTISSEMENT: Provoquer un court-circuit entre les contacts de la station d'accueil, pourrait provoquer un incendie.

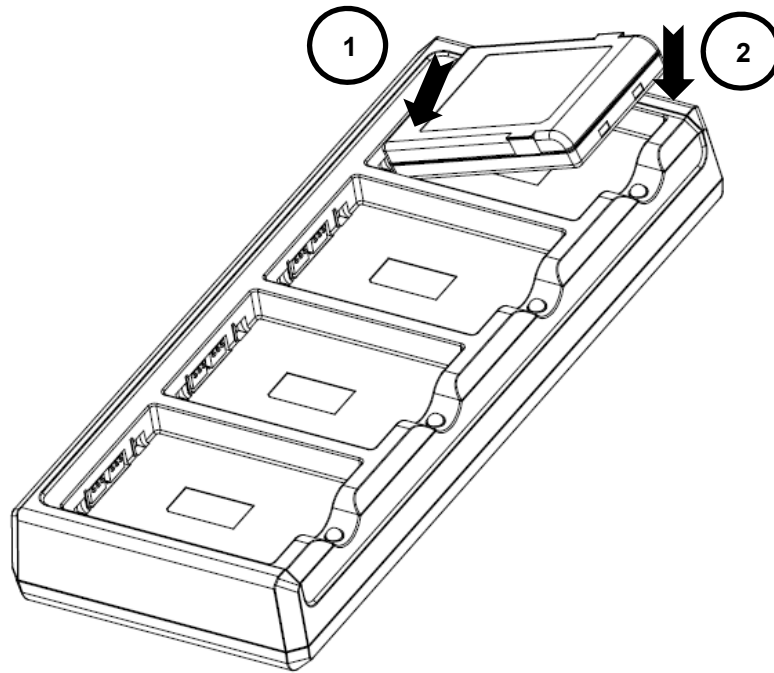

13.6 *Technical Specifications for 4-slot battery charger*

Model	4SBC (4- Slot Battery Charger)
Structural	
Dimensions	256mm(L) x 105mm(W) x 37mm(H)
Weight	4- Slot Battery Charger - 434g
Material	Polycarbonate
Color	Black
Environmental	
Operating Temperature	-20° to 55°C
Storage Temperature	-25° to +70°C
Charging Temperature	0~ 45°C (±3°C)
Electrical Static Discharge	Air: ± 15kV Direct: ± 8 kV
Humidity	95% humidity (non-condensing)
Power Supply	

Input (Universal) (from the power source)	AC 100–240 Vac. 50/60Hz 0.9A Included with Charger
Output (to the cradle)	DC 5V , 4A
Charging	
Standard Charge	Main battery: Standard Capacity:4000mAh (60-BTSC) – Approx. 5hours
Status LED	Green: charged Red: charging
Agency Approvals	
Power Supply	UL listed TUV licensed Power Supply compliant to FCC part 15, Class B
Charging	CE Marking (EMC) CISPR Pub 22
Fire Retardant	UL 94- HB