

ELLIX50 Receipt Printer

User Guide

All specifications are subject to change without notice.



SAM4S

Warning - U.S.

This equipment has been tested and founded to comply with the limits for a Class A digital device pursuant to Part 15 of the FCC Rules. These limits are designed to provide reasonable protection against harmful interference when the equipment is operated in a commercial environment. This equipment generates uses, and can radiate radio frequency energy and, if not installed and used in accordance with the instruction manual, may cause harmful interference to radio communications. In case, Operation of this equipment in a residential area is likely to cause harmful interference to radio communications. the user will be required to correct the interference at his own expense.

Notice - Canada

This Apparatus complies with class "A" limits for radio interference as specified in the Canadian department of communications radio interference regulations.

Get appareil est conforme aux normes class "A" d'interference radio tel que specifier par ministre canadien des communications dans les reglements d'interference radio.

Warning

This is a Class A product. In a domestic environment this product may cause radio interference in which case the user may be required to take adequate measures.

FCC compliance Information(for WLAN)

This device complies with part 15 of FCC Rules. Operation is subject to the following two conditions: (1) This device may not cause harmful interference, and (2) This device must accept any interference received, including interference that may cause undesired operation.

Information to the user

NOTES : *This equipment has been tested and found to comply with the limits for a Class B digital device, pursuant to part 15 of the FCC Rules.*

These limits are designed to provide reasonable protection against harmful interference in a residential installation.

This equipment generates, uses and can radiate radio frequency energy and, if not installed and used in accordance with the instructions, may cause harmful interference to radio communications. However, there is no guarantee that interference

will not occur in a particular installation. If this equipment does cause harmful interference to radio or television reception, which can be determined by turning the equipment off and on, the user is encouraged to try to correct the interference by one or more of the following measures:

- Reorient or relocate the receiving antenna.
- Increase the separation between the equipment and receiver.
- Connect the equipment into an outlet on a circuit different from that to which the receiver is connected.
- Consult the dealer or an experienced radio/TV technician for help.

[IMPORTANT NOTE]

FCC RF Radiation Exposure Statement:

This equipment complies with FCC RF radiation exposure limits set forth for an uncontrolled environment. This equipment should be installed and operated with a minimum distance of 20centimeters between the radiator and your body. This transmitter must not be co-located or operating in conjunction with any other antenna or transmitter.

Caution

Some semiconductor devices are easily damaged by static electricity. You should turn the printer "OFF" before you connect or remove the cables on the rear side, in order to guard the printer against the static electricity. If the printer is damaged by the static electricity, you should turn the printer "OFF" and contact your dealer for assistance.

INTRODUCTION

The ELLIX50 Roll Printer is designed for use with electronic instruments such as system ECR, POS, banking equipment, computer peripheral equipment, etc.

The main features of the printer are as follows:

1. High speed printing : 250mm/s, 59 lines per second(12X24 Font)
2. Low noise thermal printing.
3. Support a variety of interfaces : USB default / USB+RS-232(Serial) / USB+WLAN
USB+ETHERNET+RS-233(Serial)
4. Jam free (Implementation of automatic return of Cutter Jam)
5. Characters can be scaled up to 64 times compared to it's original size.

6. The data buffer allows the unit to receive print data even during printing.
7. Bar code printing is possible by using a bar code command.
8. Different print densities can be selected by DIP switches.
9. Peripheral units drive circuit enables control of external devices such as cash drawer.
10. 2-dimensional bar code(PDF-417) and Two color printing.

Please be sure to read the instruction in this manual carefully before using ELLIX50.

NOTES : *The Power outlet shall be near the equipment and it should be easily accessible.*

LEGISLATION AND WEEE SYMBOL

2002/96/CE Waste Electrical and Electronic Equipment Directive on the treatment, collection, recycling and disposal of electric and electronic devices and their components.



The crossed dustbin symbol on the device means that it should not be disposed of with other household wastes at the end of its working life. Instead, the device should be taken to the waste collection centres for activation of the treatment, collection, recycling and disposal procedure.

To prevent possible harm to the environment or human health from uncontrolled waste disposal, please separate this from other types of wastes and recycle it responsibly to promote the sustainable reuse of material resources.

Household users should contact either the retailer where they purchased this product, or their local government office, for details of where and how they can take item for environmentally safe recycling.

Business users should contact their supplier and check the terms and conditions of the purchase contract.

This product should not be mixed with other commercial wastes for disposal.

Contents

Chapter 1. Setting Up the Printer 7

- 1.1. Unpacking7
- 1.2. Connecting the Cables7
- 1.3. Connecting the host device8
- 1.4. Connecting the Drawer8
- 1.5. Connecting the Power Supply9
- 1.6. Installing options & Replacing the Paper Roll 10
 - 1.6.1. Partition Installation 10
 - 1.6.2. Wall Mount Installation 11
 - 1.6.3. Splash Cover Installation 12
 - 1.6.4. Paper Roll Installation 12
- 1.7. Adjustments and Settings13
 - 1.7.1. Serial Interface(RS-232C) DIP Switch Set 14
 - 1.7.2. WLAN Interface DIP Switch Set 15
 - 1.7.3. Serial+Ethernet Interface DIP Switch Set 15
- 1.8. Using the Printer16
 - 1.8.1. Control Panel (LED) 16
 - 1.8.2. Feed Button  16
 - 1.8.3. Panel lights : LED 16

CHAPTER 2. APPENDIX 17

- 2.1. Adjusting the Paper Near-End Sensor Location17
- 2.2. Printer Head Cleaning18
- 2.3. Error Status and Error Resolution 19
- 2.4. Specification20
 - 2.4.1. General Printer specification 20
 - 2.4.2. Paper specification 20

1.1. Unpacking

Your printer box should include these items. If any items are damaged or missing, please contact your dealer for assistance.

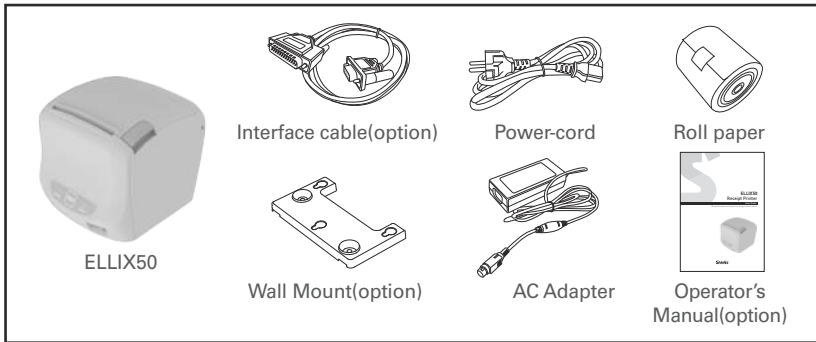

1.2. Connecting the Cables

You can connect up to three cables to the printer. They are all connected to the connector panel on the back of the printer, which is shown as below:

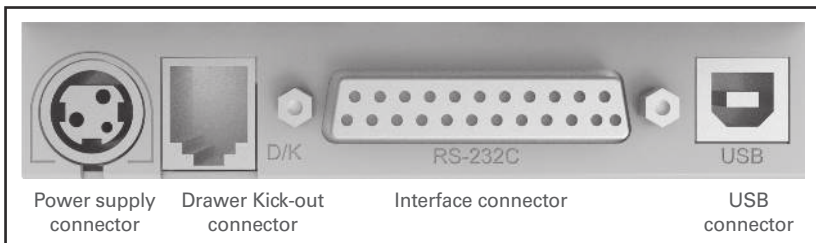

NOTES : Before connection any of the cables make sure the both the printer and connecting device are turned off.

1.3. Connecting the host device

You need the appropriate interface cable.

1. Plug the cable connector securely into the printer's interface connector.
2. Tighten the screws on both sides of the cable connector.
3. Attach the other end of the cable to the host device.



1.4. Connecting the Drawer

WARNING : Use a drawer that matches the printer specification.

Using an improper drawer may damage the drawer as well as the printer.

CAUTION : Do not connect a telephone line to the drawer kick-out connector; otherwise the printer and the telephone line may be damaged. Plug the drawer cable into the drawer kick out connector on the back of the printer next to the power supply connector.

To use the drawer, you can connect the cable to the connector.



1.5. Connecting the Power Supply

WARNING : Make sure that you use the power supply provided with the printer or equivalent.

CAUTION : When connecting or disconnecting the power supply from the printer, make sure that the power supply is not plugged into an electrical outlet. Otherwise you may damage the power supply or the printer.

If the power supply's rated voltage and your outlet's voltage do not match, contact your dealer for assistance. Do not plug in the power cord. Otherwise, you may damage the power supply or the printer.

1. Make sure the printer is turned off.
2. Plug the DC cord connector into the power jack on the printer. If it is necessary to connect the interface and the drawer, plug that connector into the port on the printer. And clean up the cables.

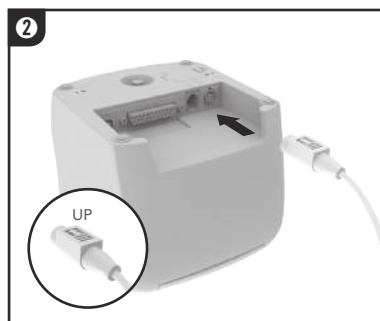

NOTES : To remove the DC cable connector, make sure the power supply's power cord is unplugged and then grasp the connector at the arrow and pull it straight out.

1.6. Installing options & Replacing the Paper Roll

1.6.1. Partition Installation

You can install the partition for 58mm paper printing on printer.

1. Push the Open-Button and open the Cover-Open.
2. Remove the partition as indicated in picture 4 below.
3. Insert the partition into the slot for 58mm wide roll as indicated in 5 & 6 below.

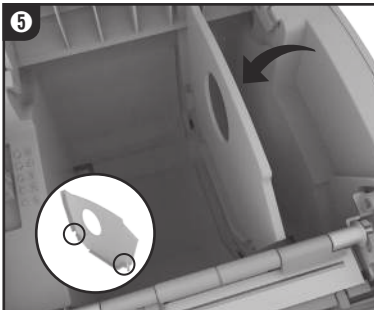
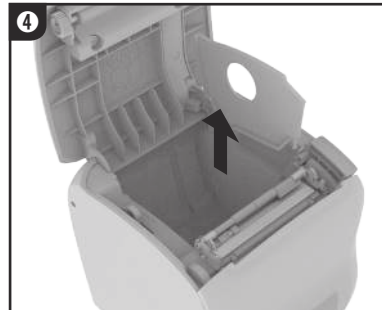
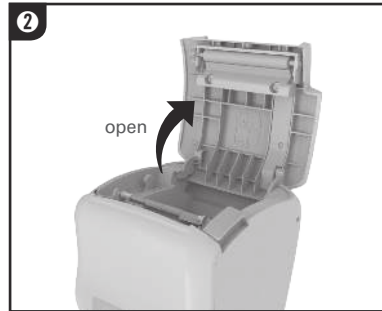

1.6.2. Wall Mount Installation

1. Use the template for Wall Mounting and mark the wall where you want to install the printer.
2. Drill 3 holes in the marked places (diameter 6.5mm depth 35mm). Insert the wall plug (A) into the hole.
3. Insert the screws into the wall plugs as in picture 3.
4. Assemble the wall mount bracket on the bottom of the printer using the screws.
5. Place the printer according to the screw head located on the anchor and fit it on the wall by sliding down.

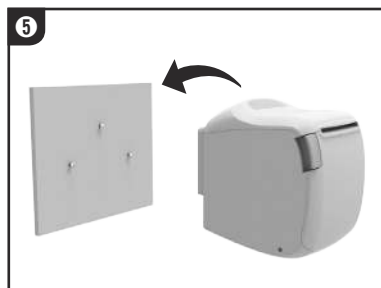
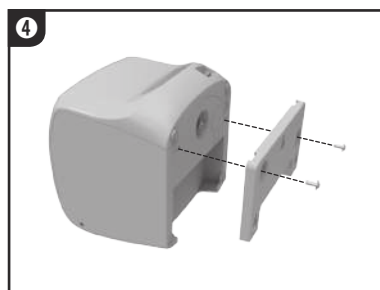
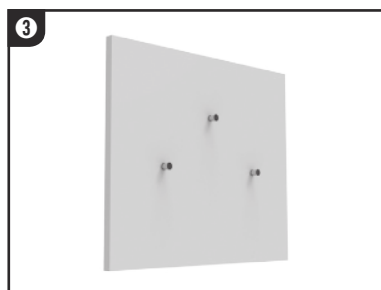
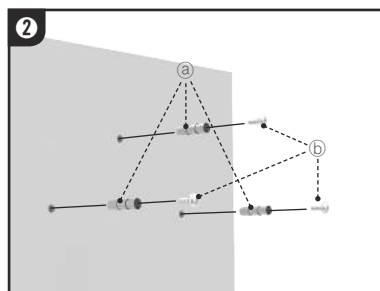
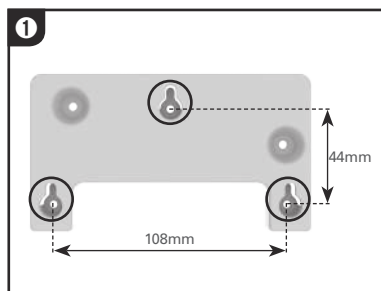

1.6.3. Splash Cover Installation

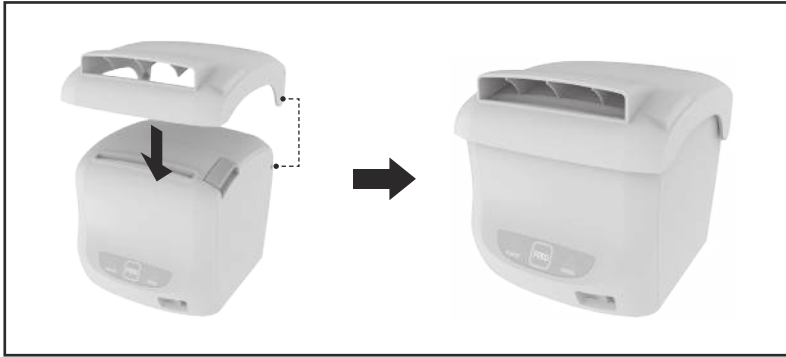

Insert the Splash cover boss(2point) into the Case lower.

1.6.4. Paper Roll Installation

NOTES : Be sure to use paper rolls that meet the specifications. Do not use paper rolls that have the paper end glued to the core.

1. Open the paper roll cover by pressing the cover-open button.

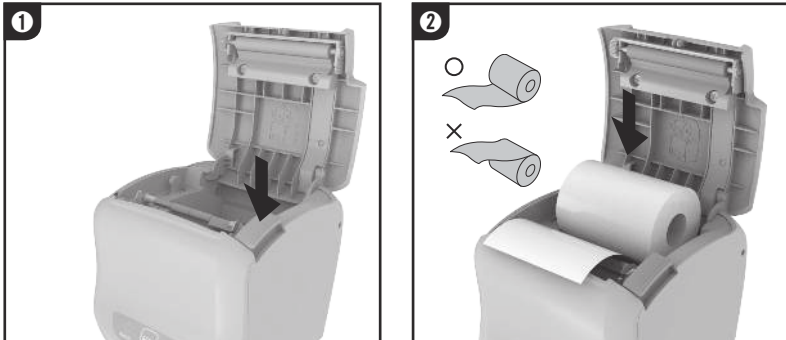

NOTES : To avoid printer damage, do not open the printer cover during printing.

2. Remove the used paper roll core if there is one.
3. Insert the paper roll as shown.
4. Pull out a small amount of paper, as shown. Then close the cover. Tear off the paper as shown.



NOTES : When closing the printer cover press firmly in the centre of the printer cover.

1.7. Adjustments and Settings

ELLIX50 is set up at the factory to be appropriate for most users. It does, however, offer some settings for users with special requirements.

DIP switches that allow you to change communication settings, such as handshaking and parity check, as well as printing density.

ELLIX50 has a near-end sensor for the paper. This can give you a warning when the paper is almost out.

<The function is not supported when used as Wall-Mount type.>

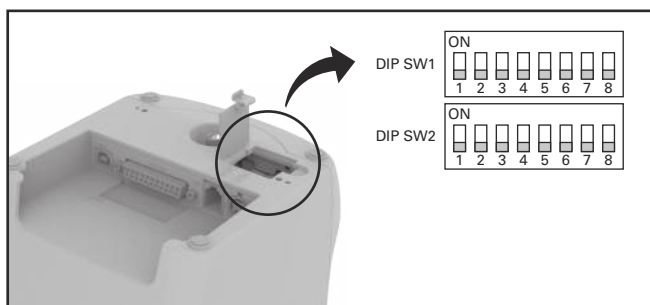

1.7.1. Serial Interface(RS-232C) DIP Switch Set

• DIP Switch Set 1 Functions

S/W	FUNCTION	ON	OFF	DEFAULT
1	Handshaking	XON/XOFF	DSR/DTR	OFF
2	Word Length	7Bit	8Bit	OFF
3	Parity Check	Yes	No	OFF
4	Parity Selection	EVEN	ODD	OFF
5	Baud rate selection	* Refer to the Following Table		OFF
6				OFF
7				OFF
8	USB Mode	VCOM	USB	OFF

» Baud rate selection

Transmission speed	SW - 5	SW - 6	SW - 7	Remark
2400 baud	ON	ON	ON	-
4800 baud	ON	ON	OFF	-
9600 baud	ON	OFF	ON	-
14400 baud	ON	OFF	OFF	-
19200 baud	OFF	ON	ON	-
38400 baud	OFF	ON	OFF	-
57600 baud	OFF	OFF	ON	-
115200 baud	OFF	OFF	OFF	-

• DIP Switch Set 2 Functions

S/W	FUNCTION	ON	OFF	DEFAULT
1	Emulation	STAR	EPSON	OFF
2	* Kitchen Bell	Enable	Disable	OFF
3	Auto Cutter	Disable	Enable	OFF
4	Self-Test Mode	Hex Dump	Self-Test Mode	OFF
5	Select Print Density	* Refer to the Following Table		OFF
6				OFF
7	Download Mode	Memory Stick	Interface	OFF
8	Auto Cutter Tuning	-	-	-

※ Kitchen Bell is option.

» Print Density

Print Density	SW-5	SW-6	Remark
1(Light)	ON	ON	-
2	OFF	OFF	Default
3	ON	OFF	-
4(Dark)	OFF	ON	-

1.7.2. WLAN Interface DIP Switch Set

• DIP Switch Set 1 Functions

S/W	FUNCTION	ON	OFF	DEFAULT
1	WLAN	Disable	Enable	OFF
2	No	-	-	-
3	No	-	-	-
4	No	-	-	-
5	No	-	-	-
6	No	-	-	-
7	No	-	-	-
8	USB Mode	VCOM	USB	OFF

• DIP Switch Set 2 Functions

※ Dip Switch 2 Functions are the same as the series interface.

1.7.3. Serial+Ethernet Interface DIP Switch Set

• DIP Switch Set 1 Functions

※ Dip Switch 1 Functions are the same as the series interface.

• DIP Switch Set 2 Functions

S/W	FUNCTION	ON	OFF	DEFAULT
1	Emulation	STAR	EPSON	OFF
2	* Kitchen Bell	Enable	Disable	OFF
3	Auto Cutter	Disable	Enable	OFF
4	Self-Test Mode	Hex Dump	Self-Test Mode	OFF
5	Select Print Density	* Refer to the page 14 Table		OFF
6				OFF
7	Download Mode	Memory Stick	Interface	OFF
8	Communication Mode	RS-232	ETHERNET	OFF

※ Kitchen Bell is option.

1.8. Using the Printer

1.8.1. Control Panel (LED)

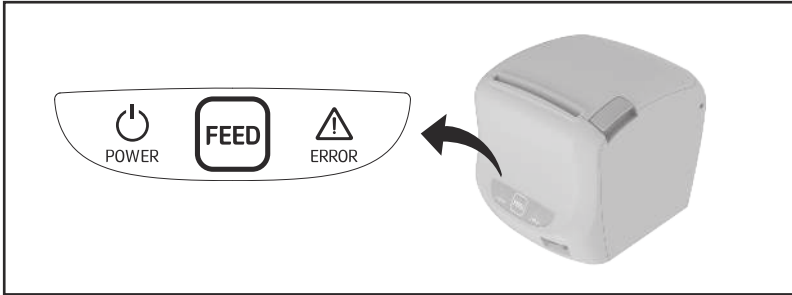

1.8.2. Feed Button

Press the FEED button once to advance paper one line. You can also hold down the FEED button to feed paper continuously. The button can be disabled by the ESC c 5 command.

1.8.3. Panel lights : LED

- **POWER LED** 

The POWER light is "ON" whenever the printer is "ON".

- **ERROR LED** 

This indicates an error. See 2-3 Error Status and Error Resolution <Page 17> for information of what to do when this light comes on.

2.1. Adjusting the Paper Near-End Sensor Location

The sensor has five sensitivity settings.

1. Push the open button and open the printer cover.
2. If you find there is too much paper remaining when the sensor is triggered, set the near end sensor to position #4 or #5.
3. Decrease the setting if the paper runs out before the sensor is triggered.

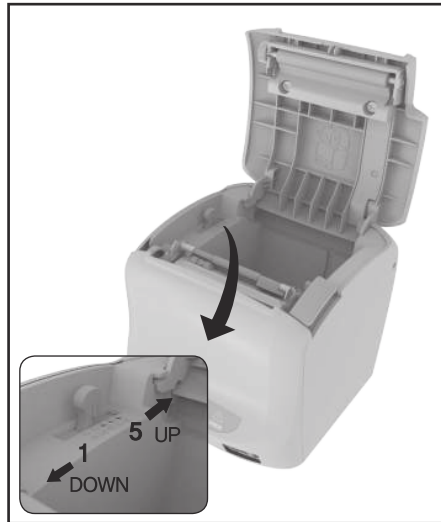

The accuracy of the Near-End sensor depends on the adjustment scale setting and the winding core diameter of the roll paper. The Near-End sensor is set at adjustment #3. This is the appropriate scale for the recommended paper thickness.

The factory default setting is at position #3.

NOTES : Paper core diameter varies by paper manufacturer.

2.2. Printer Head Cleaning

Paper dust on the heating elements may lower the printing quality. In this case, clean the printer head as follows:

NOTES : Before cleaning the inside of printer or the head, make sure the power is off.

1. Power off the printer.
2. Open the printer cover.
3. Clean the thermal elements of the printer head using a cotton swab moistened with alcohol solvent (ethanol, methanol, IPA)
4. Insert a paper roll and close the printer cover.



2.3. Error Status and Error Resolution

The printer buzzer sounds momentarily or continuously and the ERROR LED blinks when the printer indicates an Error status.

Error Status Indicators include:

- **Cutter Jam** 

If buzzer and ERROR LED beeps or blinks as like:

"Beep Beep---, Beep Beep---" the printer is on Cutter Jam error status.

» Solution

While the printer is turned on (the Power LED Is on,) press the cover button and open the cover. At this time, the cutter will automatically reset.



- **Cutter Not Home** 

If the cutter blade is not in home position when the normal waiting time, the printer enters Cutter Not Home error status.

The buzzer and ERROR LED beeps and blinks as like:

"Beep Beep Beep---, Beep Beep Beep---"

» Solution

Solved in the same way as the cutter Jam error.



- **Paper Out Error** 

The buzzer and ERROR LED beeps and blinks as like:

" Beep---,Beep---" When you press the open button to open the printer cover, the buzzer will stop. After this, you may change the paper roll and continue using the printer.

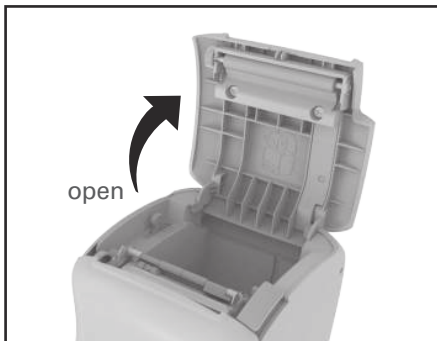

2.4. Specification

2.4.1. General Printer specification

Printing method	Thermal line printing
Dot density	180dpi
Printing width	72mm
Paper width	80mm
Characters per line(default)	42/21(Font A) 56/28(Font B)
Printing speed	59 lines/sec 250mm/sec
Receive buffer size	Max 64kbytes

NOTE : Printing speed may be slower, depending on the data transmission speed and the combination of control commands.

Supply voltage	Input voltage	100 ~ 240V AC
	Frequency	50 ~ 60 Hz
	Output voltage	+24V DC
Environmental conditions	Temperature	5 ~ 45°C(Operating) -10 ~ 50°C(Storage)
	Humidity	10 ~ 90% RH; except the paper roll.
Lifespan	Printer Mechanism(MCBF)	70,000,000 lines
	TPH	1×10 ⁸ Pulse (150km)
	Auto Cutter	1,500,000 Cut

2.4.2. Paper specification

Item	Description	Remark
Paper Type	Hansol HPK-110	Black color
	Mitsubishi PB670	Red/Black color
	Mitsubishi PB770	Blue/Black color
Paper Form	Paper Roll	
Paper Width	80(+0,-1), 3.14"(+0,-0.039")	
Paper Roll Size	Max 83mm	
Spool Outside Dia	18mm(0.71")	

The Following paper can be used instead of the specified paper above.

- TF50KS-E : Nippon Paper industries Co., Ltd.
- PD 160R : New Oji Paper Mfg, Co.,Ltd.
- F380 : Kansaki Specialty Papers,Inc.(USA)
- ※ Mitsubishi PB670 / PB770 are two color mode papers.

MEMO

MEMO

ELLIX50 Receipt Printer

OPERATOR'S Manual